



RAM[®] MOUNTS

On-Water





TABLE OF CONTENTS

03 ABOUT RAM® MOUNTS

05 SPONSORED ATHLETES

07 HOW IT WORKS, BOATING MOUNTS

10 HOW IT WORKS, KAYAKING MOUNTS

11 BOATING MOUNTS

- 12 FEATURED PRODUCTS
 - 13 RIGGING MAP FOR BOATS
 - 15 FISHFINDER MOUNTS
 - 21 RAM ROD® HOLDER MOUNTS
-

23 KAYAK MOUNTS

- 24 FEATURED PRODUCTS
 - 25 RIGGING MAP FOR KAYAKS
 - 27 RAM ROD® COMPONENTS
 - 28 RAM® UNIVERSAL ADAPT-A-POST™ TRACK BASES
 - 29 FISHFINDER MOUNTS
 - 33 RAM ROD® HOLDER MOUNTS
 - 35 TRANSDUCER MOUNTS
-

37 DEVICE MOUNTS

- 38 FEATURED PRODUCTS
- 39 PHONE MOUNTS
- 45 BUILD YOUR PHONE MOUNT
- 47 TABLET MOUNTS
- 49 BUILD YOUR TABLET MOUNT
- 51 GOPRO ADAPTER
- 53 RAM® TOUGH-POLE™ ACTION CAMERA MOUNTS
- 55 GPS & RADIO MOUNTS

57 ACCESSORIES & MORE

- 58 FISHFINDER MOUNT ACCESSORIES
 - 61 PADDLEBOARD MOUNTS
 - 63 INFLATABLE CRAFTS MOUNTS
 - 65 RAM® TOUGH-TRACK™
 - 69 PADDLE HOLDERS
 - 71 CUP HOLDER MOUNTS
 - 73 TROLLING MOTOR STABILIZERS
 - 75 SECURITY MOUNTS
 - 77 SPOTLIGHT MOUNTS
-

79 PRODUCT CHARTS & COMPATIBILITY

- 80 KAYAKING FISHFINDER COMPATIBILITY
- 81 BOATING FISHFINDER COMPATIBILITY
- 83 FISHFINDER MOUNTS
- 85 FISHING ROD HOLDERS
- 86 RAM® POST & SPLINE COMPONENTS
- 87 TRANSDUCER MOUNTS
- 87 PHONE COMPATIBILITY
- 88 RAM® X-GRIP® PHONE MOUNTS
- 88 RAM® QUICK-GRIP™ MOUNTS
- 89 WIRELESS CHARGER MOUNTS
- 89 TABLET HOLDERS
- 90 TABLET MOUNTS
- 90 CAMERA MOUNTS
- 91 HANDHELD GPS & RADIO MOUNTS
- 91 ARMS
- 91 BASES
- 91 INFLATABLE BOAT & RAFT BASES
- 91 RAM® TOUGH-TRACK™
- 92 RAM® HAND-TRACK™
- 92 RAM® CUP HOLDER MOUNTS



ABOUT RAM® MOUNTS

RAM® Mounts manufactures rugged and versatile mounting systems for cameras, tablets, and other mobile devices that can be attached nearly anywhere. Unlike other mounts on the market, RAM® allows you to secure devices where you need them most. The unique design of the RAM® Mounts system provides quick installation, adjustability, strength, vibration damping, and durability—all at a low cost. Backed by a lifetime warranty, RAM® uses powder-coated, marine-grade aluminum with lightweight and high-strength composites, stainless steel hardware, and rubber balls.

THE RAM® DIFFERENCE

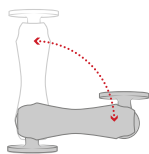

PREMIUM DESIGN

The rubber ball and socket design of our mounting systems offers a secure hold, with near-infinite adjustability and vibration damping for the most demanding environments. With thousands of components trusted by users around the world, we've been able to design and develop mounting solutions that consumers and companies previously only dreamed were possible.

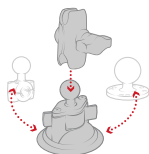

CUSTOMIZABLE

Take your phone mount from your truck to your boat, or mix and match components to create your ideal mount. Because of the modularity of the RAM® system, you can customize your solution to fit your specific needs in almost any application.

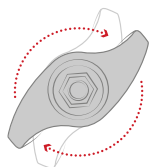

QUALITY MATERIALS

A premium design deserves the highest quality materials available, from rubber and stainless steel to high-strength composites and marine-grade aluminum. Our facilities— including powder coating, die casting, rubber injection molding, and shock and vibration testing—help us deliver on this promise to bring you inventive mounting solutions.

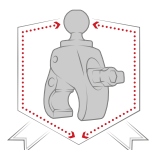

LIFETIME WARRANTY

It's simple. Our reputation as the leader of premier mounting systems means if we build it, then we guarantee it. We're confident in the quality of our products, and with our warranty, you can be too.



NATIONAL PRODUCTS INC. (NPI)

Introduced in 1995, National Products Inc. (NPI) quickly became the leading manufacturer of rugged and versatile mounting solutions. RAM® Mounts has grown to offer approximately 5,000 modular components—the most innovative product line of its kind for nearly any application and device, including phones, tablets, GPS systems, laptops, marine electronics, printers, radios, and much more.

In addition to RAM® Mounts, NPI is also the creator of award-winning IntelliSkin® sleeves and GDS® Technology™ products. IntelliSkin® sleeves ruggedize a wide range of consumer phones and tablets, while the GDS® Ecosystem™ provides users the ability to securely charge, dock, and sync devices in the most demanding environments.

NPI is proudly located in Seattle, Washington in the same neighborhood where the company was started.

PARTNER WITH RAM® MOUNTS

Here at RAM® Mounts, we believe that unfathomable things are possible with ingenuity. With a portfolio of more than 5,000 SKUs paired with innovative engineers and in-house product experts, we have the tools and expertise needed to create solutions that you didn't know were possible. We have the ability to solve your mounting challenges quickly, efficiently, and cost effectively.



SPONSORED ATHLETES

RAM® MOUNTS FISHING TEAM

At RAM® Mounts, we love fishing and we love supporting the anglers who we consider ambassadors of such a great pastime. That's why we're proud to introduce the RAM® Fishing Team—comprised of tournament anglers, licensed fishing guides, and more. Each RAM® Fishing Team member is an expert in their field utilizing countless RAM® Mounts from rod holders, fishfinder mounts, action camera mounts and more to optimize their fishing experience for fun, and for sport. Be sure to follow them via social media to stay up to date on all of their latest adventures.

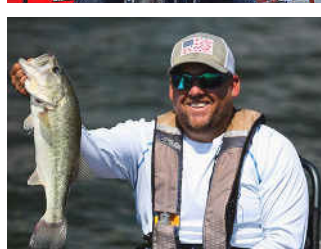
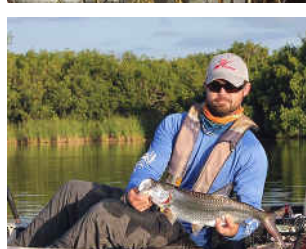
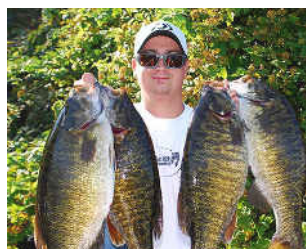

KRISTINE FISCHER

Born and raised in Weeping Water, Nebraska, Kristine wasn't one to adhere to societal norms. Growing up in a home unimpeded by the restraints of a television, she had a natural inclination to the outdoors. This paved the way for her career, as she lives full-time on the road, competing in tough kayak bass fishing tournaments.

In 2019 alone, she boasted three national level wins, and hopes to continue to break down barriers in redefining the female angler stereotype. Her favorite RAM® Mount, hands-down, is the RAM® Tough-Pole™ 48" Camera Mount with Double Pipe & Dual Track Base (RAP-411-18-18-A-GOP1).

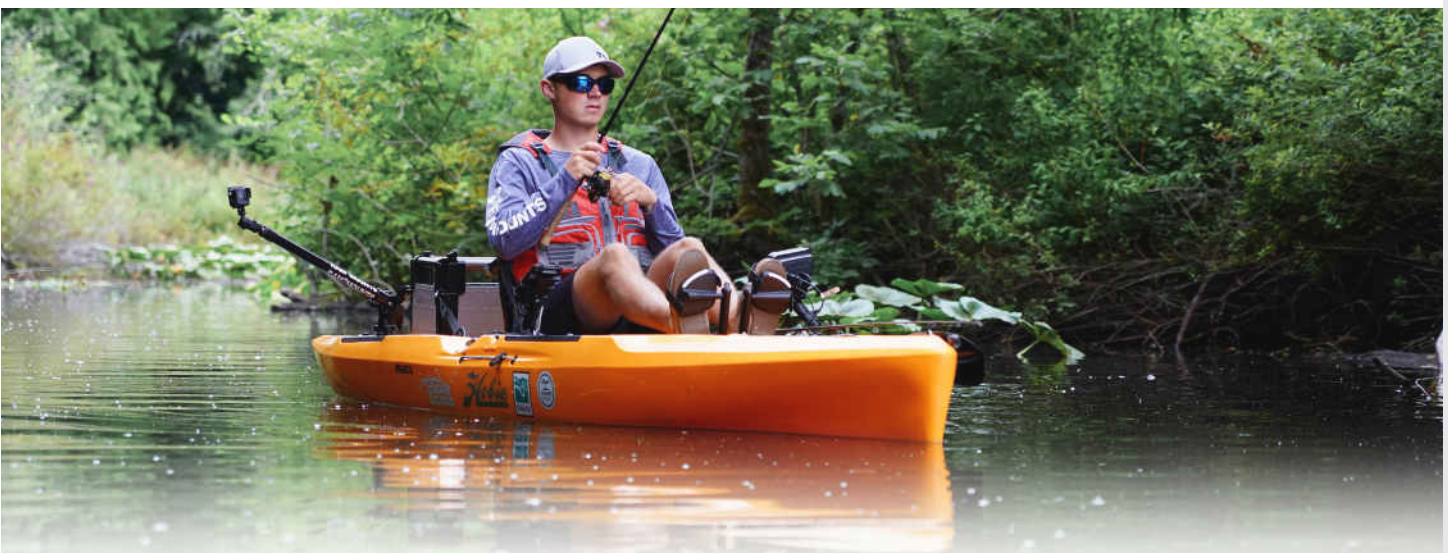

JAXTON ORR

Jaxton Orr is a 17 year-old angler from Fort Wayne, Indiana and has been fishing for 12 years. Jaxton entered the kayak fishing scene in 2017, participating in the Indiana Kayak Anglers local tournament trail and rapidly migrated to the national tournament scene the following year. In his short three year career, Jaxton has amassed 15 first place finishes, seven second place finishes and seven third place finishes. He has a heart for philanthropy and is passionate about helping others through his annual K.A.T.C.H.

(Kayak Anglers Together Can Help) charity tournament as the tournament director. Jaxton is extremely humbled and blessed to have endless support and continued encouragement from his family, friends, mentors, and sponsors as he passionately pursues his dream. His favorite RAM® Mount is the new RAM® Quick-Grip™ Wireless Charging Phone Mount with the Tough-Claw™ (RAM-B-400-A-UN14W-V7M).

HOW IT WORKS

BOATING MOUNTS DOUBLE BALL MOUNTS

Out on the water, we know that the ideal experience requires having the versatility to confidently place and adjust your expensive fishfinders and other devices to any position while maintaining the structure of the mount out on harsh waters. Ball and socket technology allows for near-infinite adjustability while providing the holding power to support heavy devices in the harshest environments. Simply attach the ball adapter to your device and connect with the correct size socket arm to place on to the mounting base in the location of your choosing.

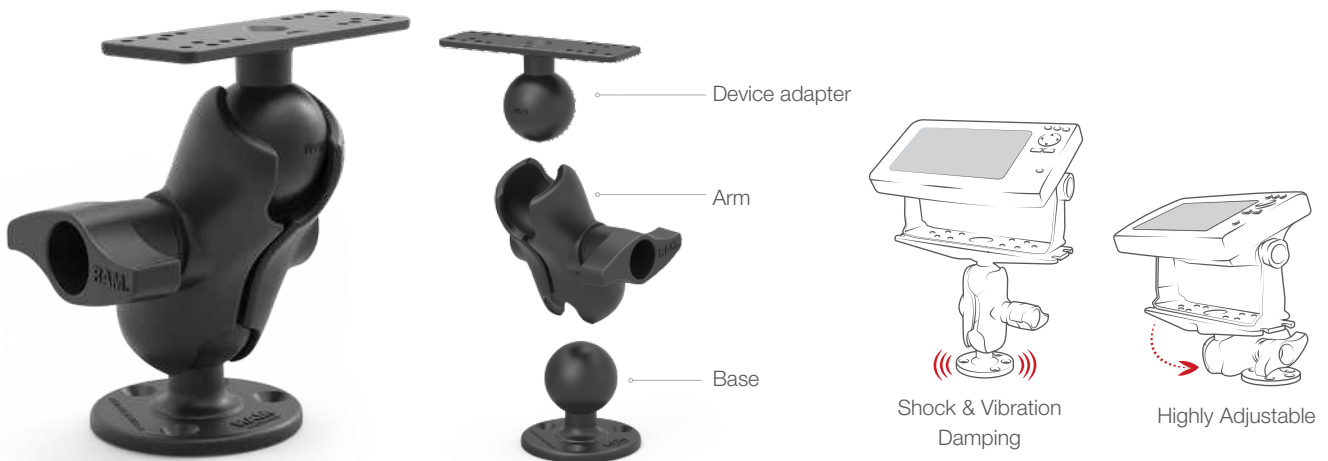

GENERAL RULE

Different Sizes of Ball & Socket Mounts are intended for different weight capacities and device sizes. For boats in heavy duty environments, RAM® recommends C Size mounts for 4" – 7" fishfinders, and D Size mounts for 8" – 16" fishfinders and plotters. Swing arm mounts with no ball components can support any size fishfinder or plotter.

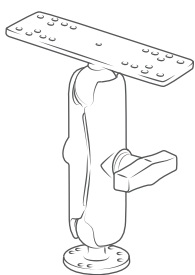

C Size 1.5" Ball Mounts
For C Size 1.5" Ball Mounts
Holds up to 4 lbs
4" – 7" Fishfinders & Plotters

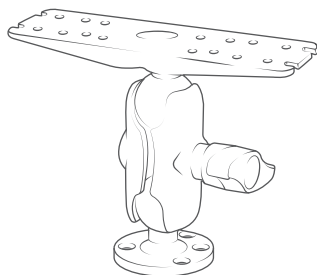

D Size 2.25" Ball Mounts
For D Size 2.25" Ball Mounts
Holds up to 6 lbs
8" – 16" Fishfinders & Plotters

AVAILABLE IN



Short & Long
Socket Arms



Cable Manager
Accessories



Locking
Accessories

SWING ARM MOUNTS

For those who desire the simple stability to adjust of your device on the X-axis, our RAM® Swing Arm Mounts support 360° horizontal rotations, available with single and double pivot points for dual-articulation. Simply attach your device to the adapter plate, similar to double mount setups, and secure the swing arm mount to the vessel for an easy 2-step installation. Our swing arm mounts can also be mounted on a horizontal or vertical flat surface for a wide range of compatible mounting locations.

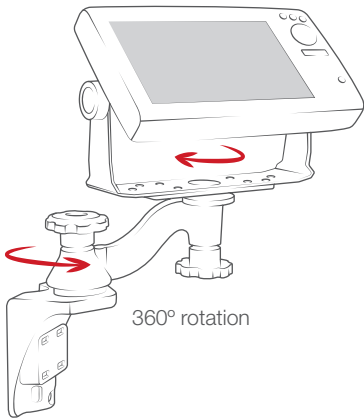

AVAILABLE IN



Single & Double Swing Arm Extensions



Horizontal & Vertical Mounting



Locking Accessories

DID YOU **KNOW**

Track Mounting is becoming the most popular way to mount fishfinders and other devices to kayaks. See page 69 for RAM® Tough-Track™ solutions.

SEEN IN THIS PHOTO:

RAM-B-400-A-GOP1

RAM® Tough-Claw™ Small Clamp Mount with Universal Action Camera Adapter



HOW IT WORKS

KAYAKING MOUNTS DOUBLE BALL MOUNTS

Space can become limited in a kayak, especially when you factor in the space you take up along with the many devices, fish containers, fishing rods, paddles, snacks and more—that's why RAM® Mounts designs the most versatile and rugged mounts on the market so you can feel confident your device is secure and adjustable to declutter the space in your kayak. Ball and socket technology allows for near-infinite adjustability while providing the holding power to support heavy devices in the harshest environments by simply attaching the ball adapter to your device and connect with the correct size socket arm to place on to the mounting base in the location of your choosing.

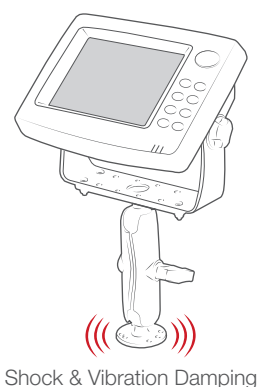

Shock & Vibration Damping

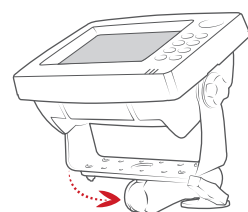

Highly Adjustable

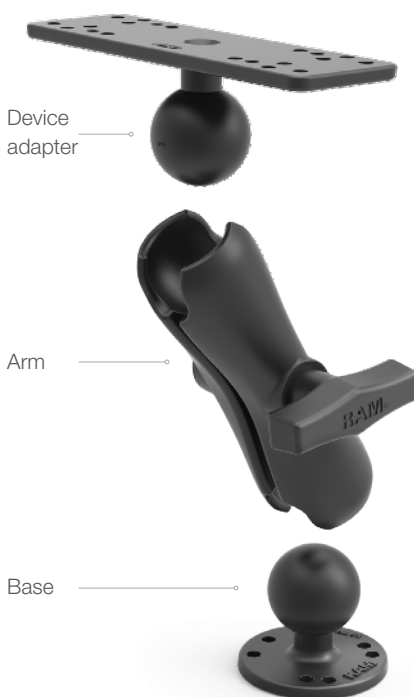

GENERAL RULE

Different Sizes of Ball & Socket Mounts are intended for different weight capacities and device sizes. For kayaks, RAM® recommends B Size mounts for up to 5" fishfinders and plotters, and C Size mounts for up to 9" fishfinders and plotters. Drill-down, track mounting and interchangeable components are available in both B Size and C Size.

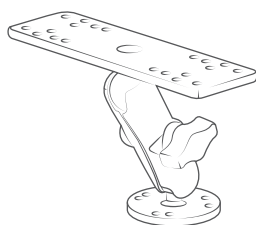

B Size 1" Ball Mounts
Holds up to 2 lbs
4" - 5" Fishfinders & Plotters

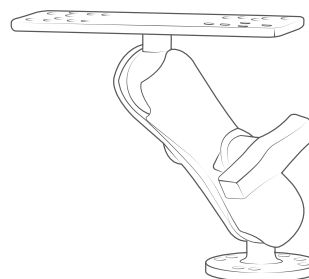

C Size 1.5" Ball Mounts
Holds up to 4 lbs
Up to 9" Fishfinders & Plotters



SEEN IN THIS PHOTO:

RAM-D-115-C

RAM® Universal Marine
Electronic Mount

BOATING MOUNTS

FEATURED PRODUCTS

When it comes to the boating market, no one makes ruggedized mounts capable holding your expensive fishfinders and fishing rods better than RAM® Mounts. See below for our most popular mounting solutions for both fishing boats and recreational. Explore all the boating mounts we have to offer for fishfinders, rod holders and more throughout this section.



RAM-D-115-C
D Size, 6.25" x 2" Plate, Short Arm



RAM-D-111-C
D Size, 11" x 3" Plate, Short Arm



RAM-111
C Size, 6.25" x 2" Plate, Medium Arm



RAM-109H
Horizontal, Single Swing Arm



RAM-D-202-25-C-202-KNOB9HU
For Humminbird Helix 8-15, Solix & Apex



RAM-101-G4
For Garmin Echomap Plus 4x, Striker Plus 4 + more



RAP-114-421
RAM ROD® Holder with Dual T-Bolt Track Base



RAM-114-BMP
RAM ROD® Holder with Combo Bulkhead Base



RAP-394-SSBMP
RAM® Tough-Tube™ Holder with Combo Bulkhead Base



RAP-434-421
RAM ROD® JR Fishing Rod Holder with Dual T-Bolt Track Base



RAM-433-BMP
RAM ROD® HD Fishing Rod Holder with Combo Bulkhead Base



RAP-400-202
RAM® Tough-Claw™ Trolling Motor Stabilizer



RIGGING MAP FOR BOATS

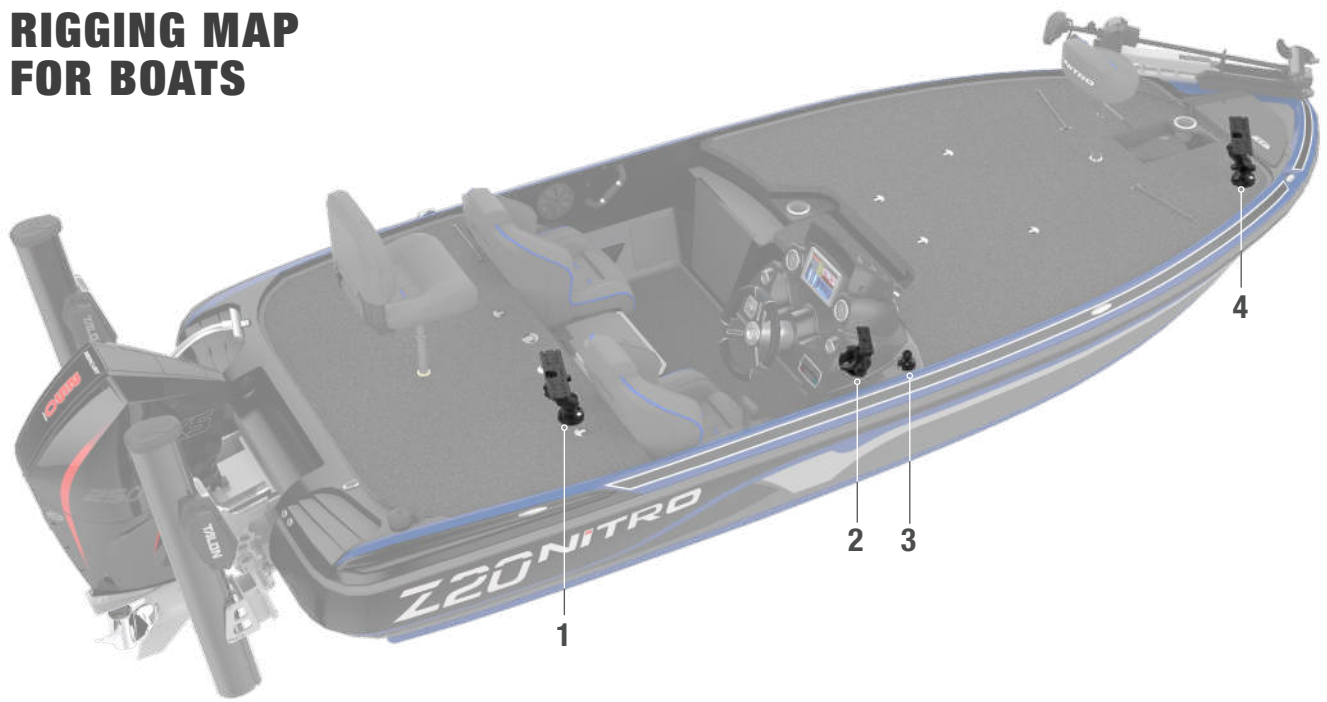

1

RAM-D-111-C
RAM® Large Marine Electronics Mount
pg. 12,17, 59



2

RAM-D-115-C
RAM® Universal Marine Electronic Mount
pg. 12,16



3

RAM-202 + RAP-403
C Size Ball Base with Cable Manager
pg. 57, 58



4

RAM-D-111-C
RAM® Large Marine Electronics Mount
pg. 12,17, 59

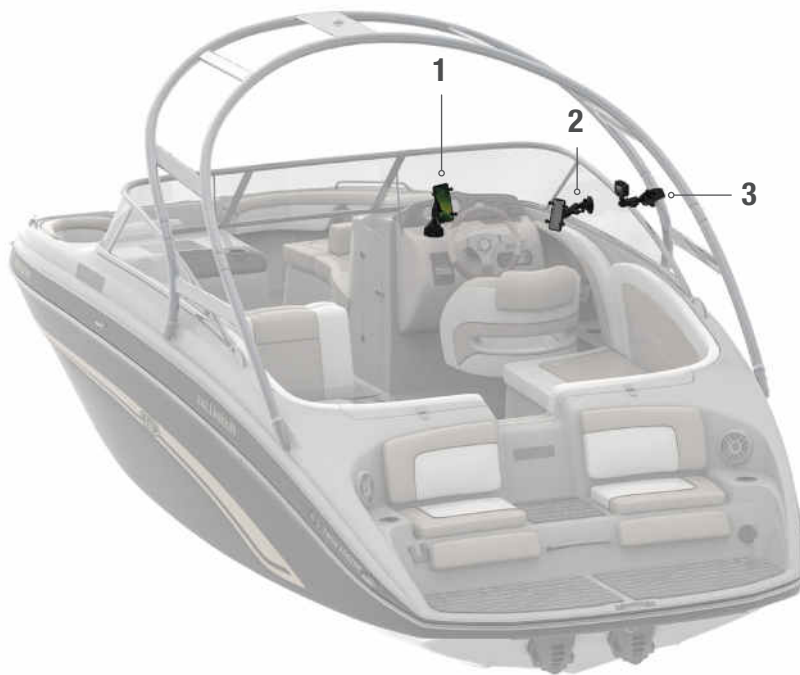

1

RAP-B-299-4-UN10U

RAM® X-Grip® Large Phone Mount with RAM® Stubby™ Cup Holder Base



2

RAM-B-166-UN7

RAM® X-Grip® Phone Mount with RAM® Twist-Lock™ Suction Cup

pg. 38



3

RAP-B-404-GOP1U

RAM® Tough-Claw™ Double Ball Mount with Universal Action Camera Adapter

SEEN IN THIS PHOTO:

RAM-D-115

RAM® Marine Electronics Mount



FISHFINDER MOUNTS

“111” SERIES

C SIZE BALL MOUNTS FOR SELECT 4” - 7” FISHFINDERS & PLOTTERS



RAM-111B
6.25" x 2" Plate



RAM-111-B
Drill-Down, Short Arm,
Overall Height 5.225"

**BEST
SELLER**



RAM-111
Drill-Down, Medium Arm,
Overall Height 7.35"



RAM-111-D
Drill-Down, Long Arm,
Overall Height 10.85"



RAM-S-111
Drill-Down, Medium Arm,
RAM® Pin-Lock™ Security
Kit for Arm Included



RAM-111-403U
Drill-Down, Medium Arm,
Cable Manager Included



RAM-111B-354-TRA1
RAM® Track Ball™,
Medium Arm



RAP-111-B
High-Strength Composite,
Drill Down, Short Arm



RAP-111
High-Strength Composite,
Drill Down, Medium Arm

“D-115” SERIES

D SIZE DRILL-DOWN BALL MOUNTS FOR SELECT 8” - 16” FISHFINDERS & PLOTTERS



RAM-D-115BU
6.25" x 2" Plate

**BEST
SELLER**



RAM-D-115-C
Short Arm, Overall Height 7.325"



RAM-D-115
Medium Arm, Overall Height 10.7"



RAM-D-115-E
Long Arm, Overall Height 15.2"

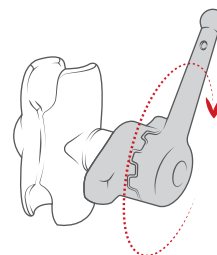
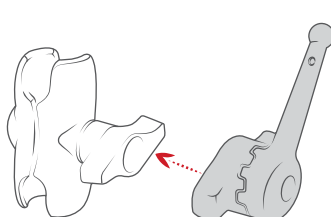

RAM-D-115-C-KNOB9H
Short Arm, RAM® Hi-Torq™ Wrench Included - Required for 16" Units

SEEN IN THIS PHOTO:

RAM-D-111

RAM® Large Marine Electronics Mount



SEEN IN THIS PHOTO:

RAM-109H

RAM® Horizontal 6" Swing Arm Mount for Fishfinders & Plotters

FISHFINDER MOUNTS CONTINUED

"D-111" SERIES

D SIZE DRILL-DOWN BALL MOUNTS FOR SELECT 8" - 16" FISHFINDERS & PLOTTERS



RAM-D-111BU
11" x 3" Plate

**BEST
SELLER**



RAM-D-111-C
Short Arm, Overall Height 8.125"



RAM-D-111
Medium Arm, Overall Height 11.5"



RAM-D-111U-E
Long Arm, Overall Height 16.03"



RAM-D-111-C-KNOB9H
Short Arm, RAM® Hi-Torq™ Wrench Included - Required for 16" Units



RAM-S-D-111U-C
Short Arm, RAM® Pin-Lock™ Security Kit for Arm Included



RAM-D-111-KNOB9H
Short Arm, RAM® Hi-Torq™ Wrench Included - Required for 16" Units



RAM-S-D-111
Medium Arm, RAM® Pin-Lock™ Security Kit for Arm Included



“109” SERIES

HORIZONTAL & VERTICAL SWING ARMS FOR SELECT FISHFINDERS & PLOTTERS - 6.25" X 2" PLATE

**BEST
SELLER**



RAM-109H
Horizontal, Single Swing Arm



RAM-109V
Vertical, Single Swing Arm



RAM-109HSB
Horizontal, Single Ball & Socket*



RAM-109VSB
Vertical, Single Ball & Socket*



RAM-109H-1
Horizontal, Double Swing Arm



RAM-109V-1
Vertical, Double Swing Arm



RAM-109H-2
Horizontal, Double Ball & Socket*



RAM-109V-2
Vertical, Double Ball & Socket*

*Ball & Socket Swing Arm Mounts are only recommend for up to 7" Fishfinders & Plotters



SEEN IN THIS PHOTO:

RAM-101-G4
RAM® Double Ball Mount with
Garmin Fishfinder Hardware



FISHFINDER MOUNTS CONTINUED

CUSTOM MOUNTS



BEST SELLER

RAM-101-G4
 Marine-Grade Aluminum, Supports
 Echomap Plus 4x, echoMAP CHIRP
 43cv, Striker Plus 4



RAP-101U-G4
 High-Strength Composite, Supports Echomap Plus
 4x, echoMAP CHIRP 43cv, Striker Plus 4



BEST SELLER

RAM-101-L012
 Marine-Grade Aluminum, Supports
 HOOK Reveal 5



RAP-101-L012
 High-Strength Composite, Supports HOOK Reveal 5



RAM-101-L011
 Marine-Grade Aluminum,
 Supports Elite-7 Ti2



RAP-101U-L011
 High-Strength Composite,
 Supports Elite-7 Ti2



RAM-109H-2B-B-L011
 Swing Arm Mount,
 Supports Elite-7 Ti2



RAM-202-153-202
 Medium Arm, Supports Helix 5



RAM-202-153-B-202
 Short Arm, Supports Helix 5



RAP-202-153-202
 High-Strength Composite, Medium Arm,
 Supports Helix 5



RAM-202-24-202
 Medium Arm, Supports Helix 7



RAM-202-24-B-202
 Short Arm, Supports Helix 7

BEST SELLER



RAM-D-202-25-C-202
 Short Arm, Supports
 Helix 8, 9, 10, and Solix 10



RAM-D-202-25-C-202-KNOB9HU
 Short Arm, Supports
 Helix 8-15, Solix & Apex

DID YOU **KNOW**

The RAM ROD® HD can function as a tube style holder, by positioning the holder vertically, and snapping the bottom arm stop into place.



SEEN IN THIS PHOTO:

RAP-433-BMP

RAM ROD® HD Rod Holder with bulkhead/flat surface base

RAP-B-GOP2-A-GOP1



GoPro® Adapter Mount with short arm

RAM ROD® HOLDER MOUNTS

BOATING

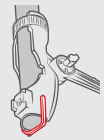

With popular rod holder product lines like the RAM ROD® and RAM® Tube™ series, anglers have trusted RAM® out on the water for years. The high-strength materials, the user friendly design and modularity are what set our rod holders apart from the competition. Choose a complete fishing rod holder kit, or select your preferred mounting base and pair it with the rod holder that best suits your fishing needs.

RAM ROD® HD FEATURES

-  Fits spinning reels and baitcasters
-  Optional GoPro mounting point
-  Converts to tube style holder





RAM ROD® FEATURES

-  Fits spinning reels and baitcasters
-  Locking latch for added security
-  Quick one handed insertion and removal

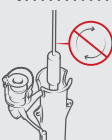

RAM® TOUGH-TUBE™ FEATURES

-  Secure and durable tube design
-  Rotate up to 180 degrees
-  Internal flange prevents spinning of rod



POPULAR MOUNTS



RAP-394-SSBMP
RAM® Tough-Tube™ with
Combo Bulkhead Base



RAP-433-PA-411
RAM ROD® HD with
RAM® Track-Node™ Base



RAM-114-F
RAM ROD® with Flush Base



RAM-114-BU
RAM ROD® with Bulkhead Base



SEEN IN THIS PHOTO:

RAP-AAP-162U

RAM® Adapt-A-Post™ with Flush Rod Wedge Adapter

RAP-114-APB2

RAM® Adapt-A-Post™ with Adjustable 13.5" Extension Arm

RAM-114-NB

RAM ROD® Fishing Rod Holder with 6" Spline Post



KAYAK MOUNTS

FEATURED PRODUCTS

Carefully crafted to elevate the fishing experience of anglers all over the world, RAM® Mounts designs lightweight, durable solutions that do not encroach on the limited space available in your kayak. See below for our most popular mounting solutions for both fishing kayaks and recreational. Explore all the kayaking mounts we have to offer for fishfinders, rod holders, transducers and more throughout this section.



RAM-B-111
B Size, 6.25" x 2" Plate, Medium Arm



RAM-111
C Size, 6.25" x 2" Plate, Medium Arm



RAM-B-LO12-354-TRA1
RAM® Track Ball™, Supports HOOK Reveal 5



RAP-434-421
RAM ROD® JR Fishing Rod Holder with Dual T-Bolt Track Base



RAP-433-BMP
RAM ROD® HD Fishing Rod Holder with Combo Bulkhead Base



RAP-394-SSBMP
RAM® Tough-Tube™ Holder with Combo Bulkhead Base



RAP-114-421
RAM ROD® Holder with Dual T-Bolt Track Base



RAP-390-RB-TRA1
RAM® Tube Jr.™ with RAM® Track Ball™ Base



RAM-B-316-18-TRA1-TRA1
RAM® Track Ball™ Transducer Mount with 18" Aluminum Rod



RIGGING MAP FOR KAYAKS

Using RAM® mounting solutions, there are countless ways to customize your kayak using tracks and bases to secure your fishfinder, fishing rod, action camera and much more. This map provides inspiration with a recommended example of a common rigging scenario.

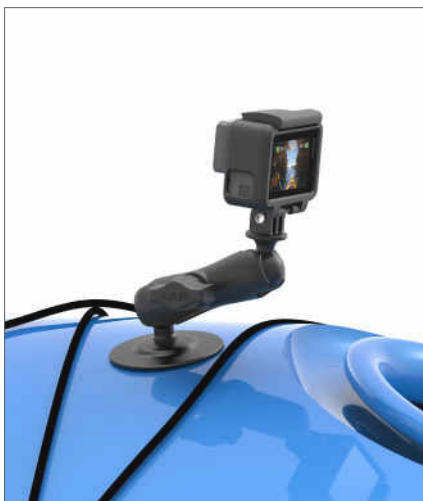
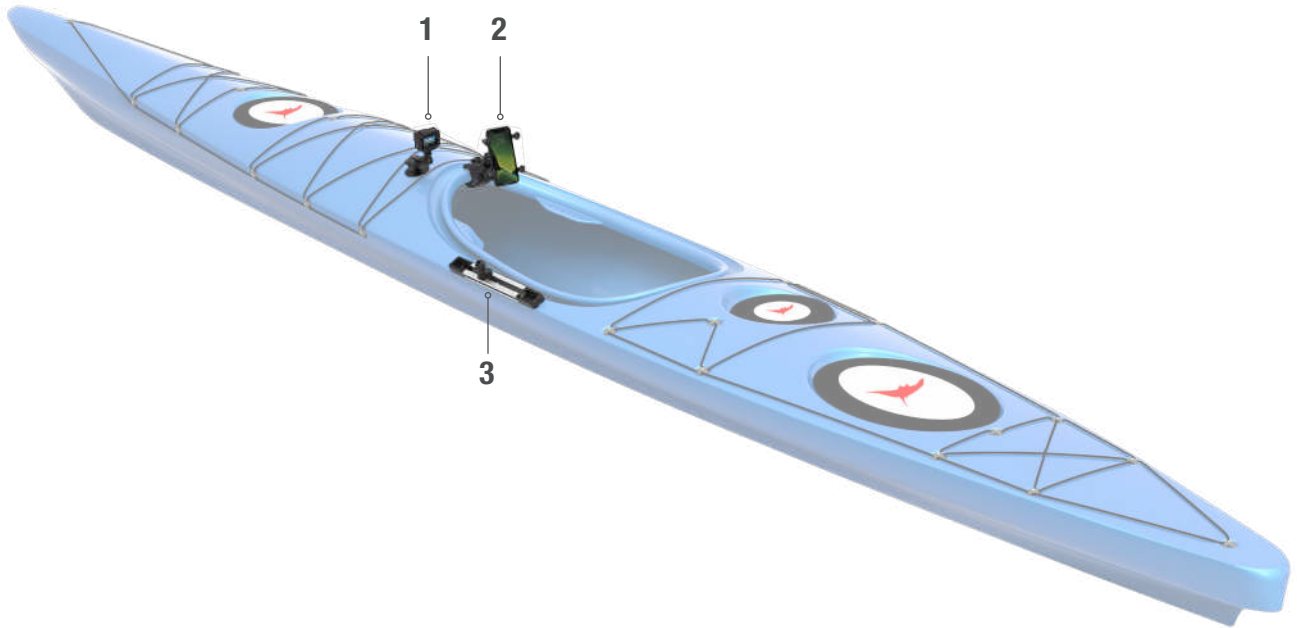

1
RAP-B-378-202U-GOP1
 RAM® Flex Adhesive Double Ball Mount with Action Camera Adapter

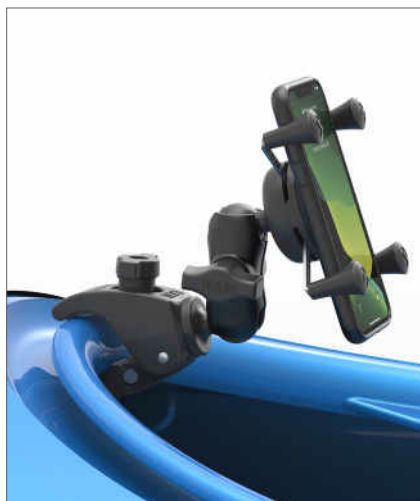

2
RAM-B-400-A-HOL-UN7BU
 RAM® X-Grip® Phone Mount with RAM® Tough-Claw™ Small Clamp Base

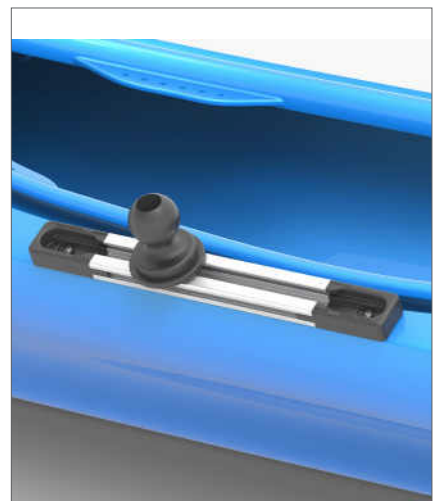

3
RAM-TRACK-EXA-5
 5" Modular Aluminum RAM® Tough-Track™
pg. 66, 70

RAP-B-354-TRA1
 RAM® Track Ball™ with T-Bolt Attachment
pg. 41, 46

RIGGING MAP FOR KAYAKS CONTINUED

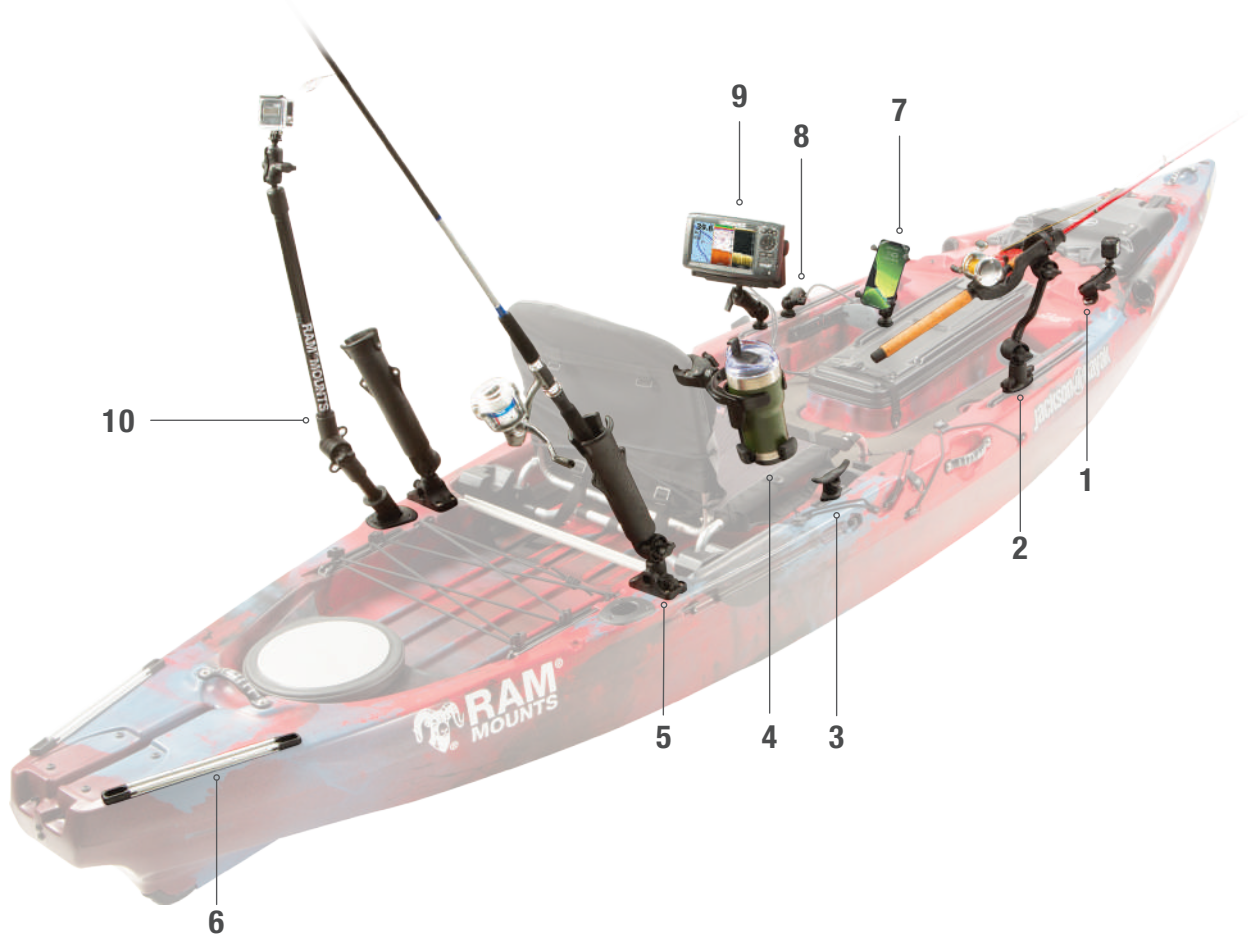

1
Ball Adapter for GoPro®
pg. 52



2
RAM® ROD® Holder
pg. 34



3
RAM® Tough-Cleat™
pg. 76



4
RAM® Level Cup™ XL
pg. 72



5
RAM® Tough-Tube™
Rod Holder
pg. 27



6
RAM® Tough-Track™
pg. 66



7
RAM® X-Grip®
Phone Mount
pg. 40, 45, 46



8
Transducer Mount
pg. 35



9
Fishfinder Mounts
pg. 29



10
RAM® Tough-Pole™
Camera Mount
pg. 53

RAM ROD[®] COMPONENTS

There is no shortage of areas you can mount your rod holders. RAM[®] offers a variety of different bases and extension arms to achieve the ideal mounting setup for your fishing rods for both boating and kayaking vessels. All rod holder components are designed to swap between type of rod holder making it easier to shop for what you need, hassle-free.

HOLDERS



RAP-394-SST
RAM[®] Tough-Tube™ with 3" Post



RAP-434-NB
RAM ROD[®] JR with 4" Post



BEST SELLER

RAP-433-NB
RAM ROD[®] HD with 6" Post



RAM-114-NB
RAM ROD[®] with 6" Post



RAP-390
RAM[®] Tube Jr.™ with 6" Post

SPLINE POST BASES



RAM-114BM
Bulkhead Base



RAM-114FM
Flush Base



RAM-114BMP
Combo Bulkhead/Flat Surface Base



BEST SELLER

RAP-421
Dual T-Bolt Track Base



RAP-411-AAPU
RAM[®] Track-Node™ with RAM[®] Adapt-A-Post™

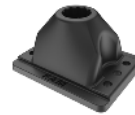

RAM-114DTM
Deck and Track Base

EXTENSIONS & ACCESSORIES



RAM-114RM
Base Rail Adapter



BEST SELLER

RAP-114-APB2
RAM[®] Adapt-A-Post™ with Adjustable 13.5" Extension Arm



RAP-114-APB3U
RAM[®] Adapt-A-Post™ with Adjustable 16" Extension Arm



RAP-114-EX6
RAM[®] Adapt-A-Post™ with 9" Extension Post

RAM® UNIVERSAL ADAPT-A-POST™ TRACK BASES KAYAKING

The RAM® Universal Adapt-A-Post™ Base is the revolutionary answer to combine compatibility across post and spline systems from RAM® Mounts, Scotty, Fish-On, Railblaza, Cannon, Brocraft, Cabela's and Bass Pro Shops. Available for all mounting locations including tracks, flat surfaces, rails and Hobie's H-Rail system, the RAM® Universal Adapt-A-Post™ is a true game changer. Each version of the RAM® Universal Adapt-A-Post™ features a quick-release button to safely disengage the rod holder as well as keep it secure while fishing out on the water.

FEATURES



Universal post & spline insert compatible with most brands



Quick-release mechanism for easy install and removal of rod holder



Track-base version contains locking button to prevent base from spinning loose



RAP-AAPUTU

RAM® Universal Adapt-A-Post™ Track Bases



RAP-AAPUBU

RAM® Universal Adapt-A-Post™ Bulkhead Drill-Down Base



RAP-AAPUDT-1U

RAM® Universal Adapt-A-Post™ Dual T-Bolt Track Base



RAP-AAPUDTU

RAM® Universal Adapt-A-Post™ 2-Hole Drill-Down Base



RAP-AAPUDU

RAM® Universal Adapt-A-Post™ 4-Hole Drill-Down Base



RAP-AAPUH-1U

RAM® Universal Adapt-A-Post™ for Hobie H-Rail Adapters

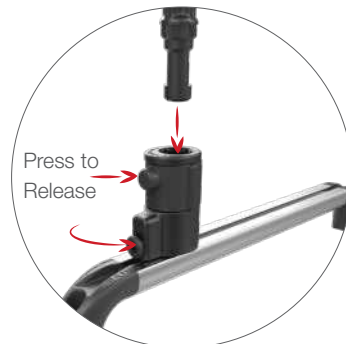

SEEN IN THIS PHOTO:

RAM-B-111
Drill-Down,
Medium Arm,
Overall Height 5"



FISHFINDER MOUNTS

"B-111" SERIES
B SIZE BALL MOUNTS FOR SELECT
4" - 5" FISHFINDERS & PLOTTERS



RAM-B-111B
6.25" x 2" Plate



RAM-B-111U-A
Drill-Down, Short Arm, Overall Height 3.75"

**BEST
SELLER**



RAM-B-111
Drill-Down, Medium Arm, Overall Height 5"



RAM-B-111U-C
Drill-Down, Long Arm, Overall Height 7.3125"



RAP-B-111-A
High-Strength Composite, Drill-Down, Short Arm



RAP-B-111
High-Strength Composite, Drill-Down,
Medium Arm



RAP-B-111B-354-TRA1
RAM® Track Ball™, Medium Arm



RAM-B-111-238U
Drill Down with Diamond Base, Medium Arm



RAM-S-B-111
Drill-Down, Medium Arm, RAM® Pin-Lock™
Security Kit for Arm Included



RAM-SG-B-111
Drill-Down, Medium Arm, RAM® Pin-Lock™
Security Kit for Arm + Gimbal Bracket Included



SEEN IN THIS PHOTO:

RAM-111B-354-TRA1
RAM® Track Ball™
Marine Electronic Mount



FISHFINDER MOUNTS CONTINUED

“111” SERIES
C SIZE BALL MOUNTS FOR SELECT
4” - 7” FISHFINDERS & PLOTTERS



RAM-111-B
Drill-Down, Short Arm, Overall Height 5.225”



RAM-111
Drill-Down, Medium Arm, Overall Height 7.35”



RAM-111B
6.25” x 2” Plate

RAM-111-D
Drill-Down, Long Arm, Overall Height 10.85”



RAM-S-111
Drill-Down, Medium Arm, RAM® Pin-Lock™ Security Kit for Arm Included



RAM-SG-111
Drill-Down, Medium Arm, RAM® Pin-Lock™ Security Kit for Arm + Gimbal Bracket Included



RAM-111B-354-TRA1
RAM® Track Ball™, Medium Arm



RAP-111-B
High-Strength Composite, Drill Down, Short Arm



RAP-111
High-Strength Composite, Drill Down, Medium Arm



SEEN IN THIS PHOTO:

RAM-B-L012-354-TRA1

RAM® Track Ball™ Double Ball Mount for Lowrance Hook² & Reveal Series

FISHFINDER MOUNTS CONTINUED

CUSTOM MOUNTS

GARMIN



RAM-B-101-G4
Marine-Grade Aluminum,
Supports Echomap Plus 4x,
echoMAP CHIRP 43cv, Striker Plus 4



RAP-B-101U-G4
High-Strength Composite,
Supports Echomap Plus 4x,
echoMAP CHIRP 43cv, Striker Plus 4

LOWRANCE



RAM-B-101-L012
Marine-Grade Aluminum,
Supports HOOK Reveal 5



RAP-B-101-L012
High-Strength Composite,
Supports HOOK Reveal 5



**BEST
SELLER**

RAM-B-L012-354-TRA1
RAM® Track Ball™,
Supports HOOK Reveal 5

Raymarine



RAM-B-202-379-M616
Drill-Down, Supports Dragonfly 5
Pro & 7 Pro



RAM-B-400-379-M616
RAM® Tough-Claw™, Supports
Dragonfly 5 Pro & 7 Pro



SEEN IN THIS PHOTO:

RAP-B-202-153-354-TRA1
 RAM® Track Ball™ Double Ball
 Mount for Humminbird Helix 5

FISHFINDER MOUNTS / CUSTOM MOUNTS CONTINUED



RAM-202-153-B-202
 Short Arm, Supports Helix 5



RAM-202-153-202
 Medium Arm, Supports Helix 5



RAP-202-153-202
 High-Strength Composite,
 Medium Arm, Supports Helix 5



RAP-B-202-153-354-TRA1
 RAM® Track Ball™, Supports
 Helix 5



RAM-202-24-B-202
 Short Arm, Supports Helix 7



RAM-202-24-202
 Medium Arm, Supports Helix 7



RAM-202-24-354-TRA1
 RAM® Track Ball™, Supports Helix 7



RAM-202-24-B-202
 Drill-Down, Supports
 PiranhaMax 4



RAM-B-107-1U
 High-Strength Composite,
 Drill-Down, Supports
 PiranhaMax 4



RAP-B-107-1B-354-TRA1
 RAM® Track Ball™, Supports
 PiranhaMax 4



RAM-B-107-1U-238
 Drill-Down with Diamond Base,
 Supports PiranhaMax 4

DID YOU **KNOW**

The high strength composite materials in RAM ROD® Holder Mounts are suitable for saltwater and freshwater environments.

SEEN IN THIS PHOTO:

RAP-385-12-394

RAM® Tough-Tube™ with
RAM® Press-N-Lock™ Base

RAM ROD® HOLDER MOUNTS

KAYAKING

RAM® offers an extensive line of rod holders that are best suited to your kayak fishing needs. Whether you're using a spinning, baitcasting or trolling rod, RAM® has you covered. Pair any of our rod holders with our new RAM® Universal Adapt-A-Post™ or a truly optimized fishing experience. Select a complete kit or mix and match to find your ideal rod holder and mounting base.

RAM ROD® FEATURES

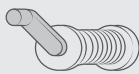
 Fits spinning reels and baitcasters

 Locking latch for added security

 Quick one handed insertion and removal



RAM® TUBE JR.™ FEATURES

 Clean, low profile design

 Reversible tube supports spinning reels and baitcasters

 Form-factor notches lock fishing rods in place



RAM ROD® JR FEATURES

 Clean, low profile design

 Optional GoPro mounting point

 Rubber strap secure fishing rods in place



POPULAR MOUNTS



RAP-114-421
RAM ROD® with Dual T-Bolt Track Base



RAM-114-B
RAM ROD® with Bulkhead Base



RAP-390-RB-TRA1
RAM® Tube Jr.™ with RAM® Track Ball™ Base



RAP-434-BMP
RAM ROD® JR with Combo Bulkhead Base

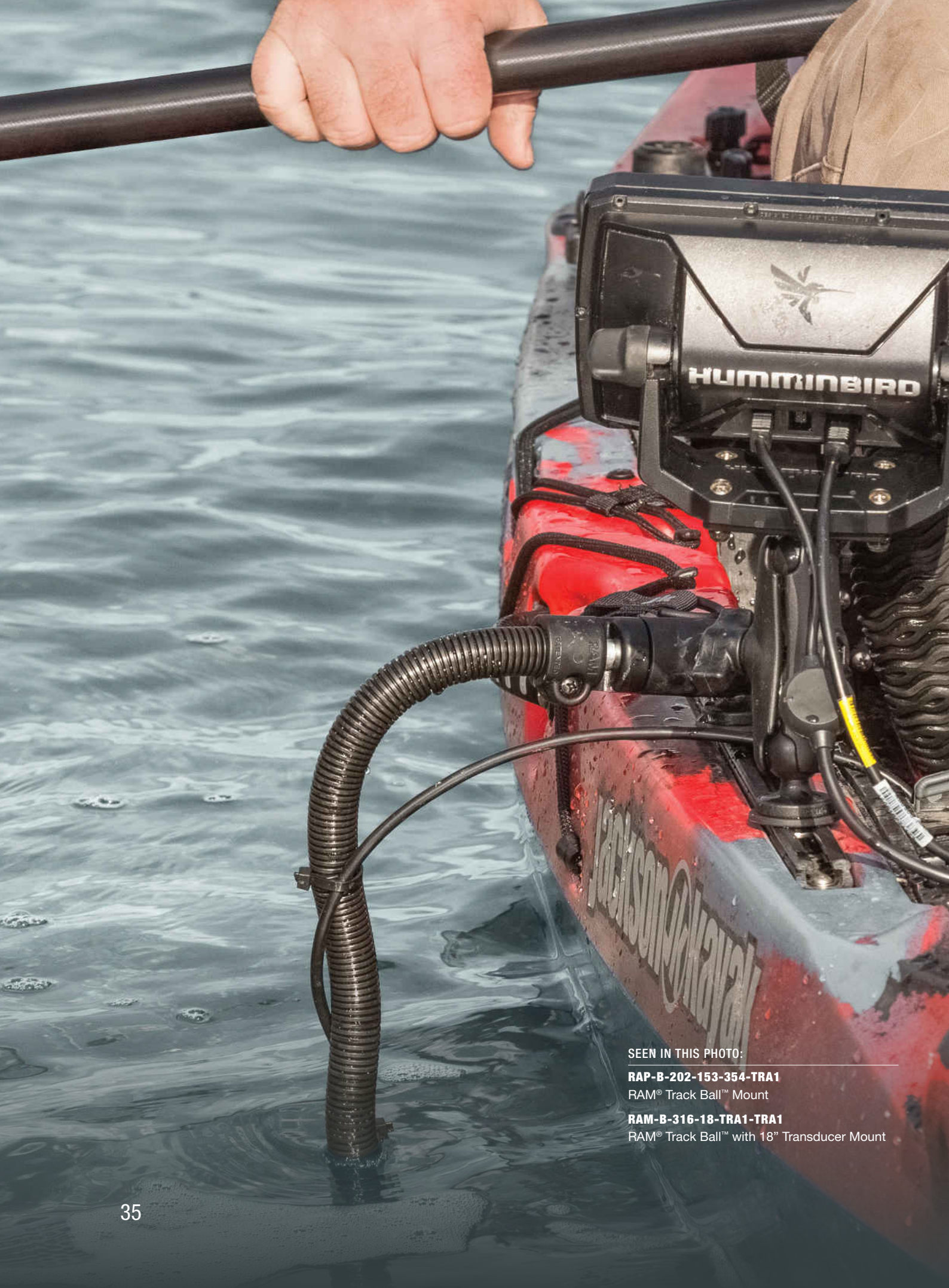

SEEN IN THIS PHOTO:

RAM-B-202-153-354-TRA1

RAM® Track Ball™ Mount

RAM-B-316-18-TRA1-TRA1

RAM® Track Ball™ with 18" Transducer Mount

TRANSDUCER MOUNTS

KAYAKING

Kayak fishing is all about adaptability, and RAM® Mounts offers the widest selection of kayak fishing accessories to adapt to a wide range of fishing scenarios. RAM® Mounts offers a deployable transducer arm for kayaks. This solution enables the quick and effective deployment and retrieval of your transducer, while protecting your transducer from damage. Perfect for kayak applications, the transducer arm can quickly be retrieved if you enter shallow water or when beaching your kayak.

FEATURES



Flex rod allows for optimal adjustment to prevent drag



Compatible with any transducer with a 1/4" screw



Quick deployment and retrieval hinge

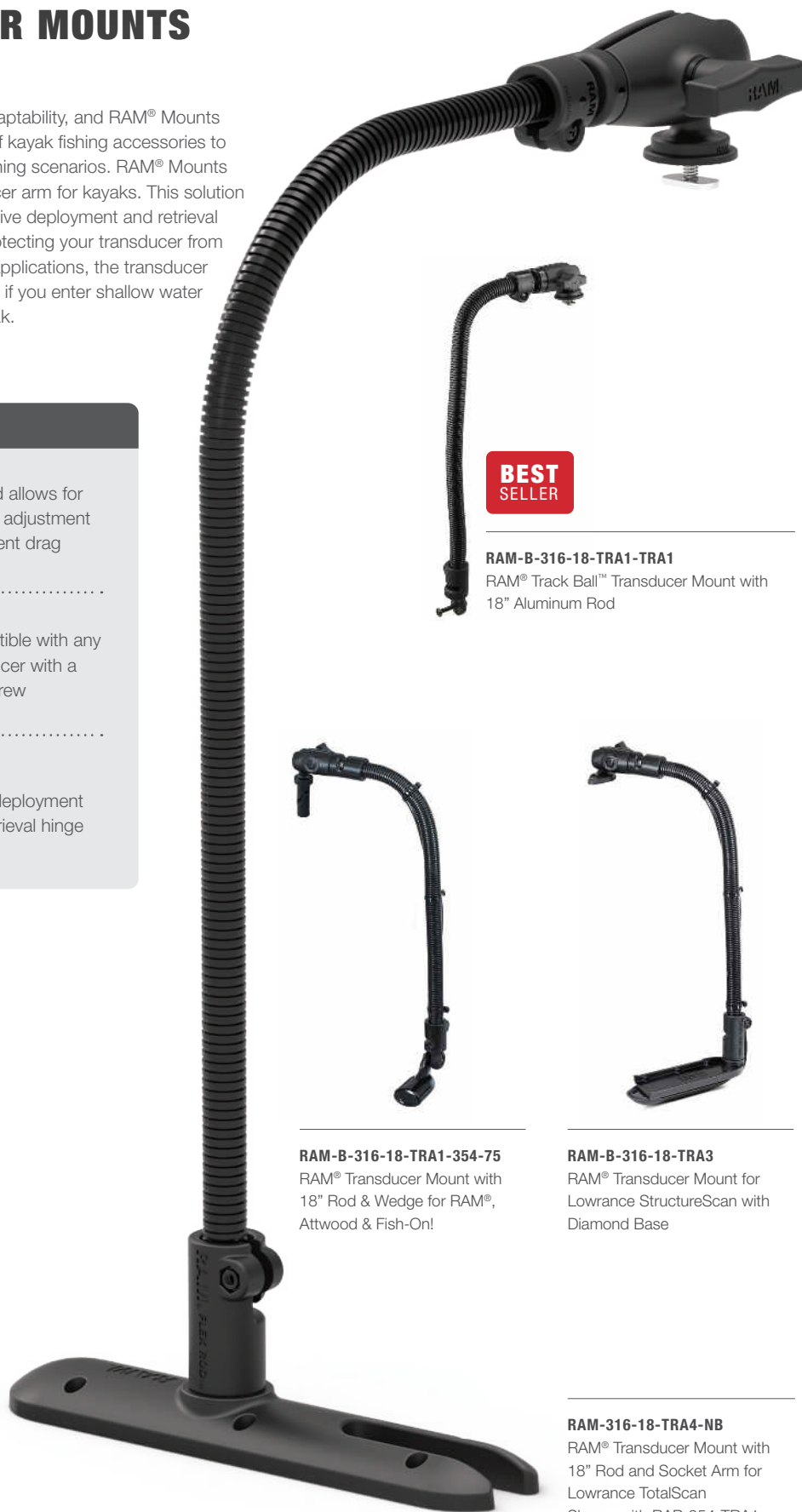

**BEST
SELLER**

RAM-B-316-18-TRA1-TRA1

RAM® Track Ball™ Transducer Mount with 18" Aluminum Rod



RAM-B-316-18-TRA1-354-75

RAM® Transducer Mount with 18" Rod & Wedge for RAM®, Attwood & Fish-On!



RAM-B-316-18-TRA3

RAM® Transducer Mount for Lowrance StructureScan with Diamond Base

RAM-316-18-TRA4-NB

RAM® Transducer Mount with 18" Rod and Socket Arm for Lowrance TotalScan
Shown with RAP-354-TRA1



SEEN IN THIS PHOTO:

RAP-B-202-GOP1-A-294-18U
RAM® Tough-Pole™ 18" Action
Camera System with Spline Post

RAP-421
RAM® Dual T-Bolt Track Base
for Spline Posts



DEVICE MOUNTS

FEATURED PRODUCTS

Stay worry-free on the water with RAM® phone, tablet, camera mounts and more. With popular options like the RAM® X-Grip® and form-fitting cradles, take full advantage of your phone or tablet's camera, fishfinder apps and maps—while our favorite action camera brands, including GoPro and DJI, are compatible with RAM® camera mounts, which provide vibration damping for a clear shot.



RAM-B-166-UN7
RAM® X-Grip® Phone Mount with RAM® Twist-Lock™ Suction Cup Base



RAM-B-166-UN10
RAM® X-Grip® Large Phone Mount with RAM® Twist-Lock™ Suction Cup Base



RAM-B-166-PD3
RAM® Quick-Grip™ Phone Mount with RAM® Twist-Lock™ Suction Cup Base



RAM-B-138-PD4U
RAM® Quick-Grip™ XL Spring-Loaded Phone Mount with Drill-Down Base



RAM-B-400-A-UN12W-V7M
RAM® Tough-Charge™ Waterproof Wireless Charging Mount with Tough-Claw™



RAM-B-400-A-UN14W-V7M
RAM® Quick-Grip™ Waterproof Wireless Charging Mount with Tough-Claw™



RAP-B-400-GOP1
RAM® Tough-Claw™ Double Ball Mount with Universal Action Camera Adapter



RAP-411-18-18-A-GOP1-1
RAM® Tough-Pole™ Camera Mount with Double Pipe & RAM® Track-Node™ Base



RAM-HOL-GA76U
RAM® Spine Clip Holder for Garmin Handheld Devices



DID YOU KNOW
All RAM® X-Grip® Holders come with an optional safety tether to keep your phone protected in any rough environments.

SEEN IN THIS PHOTO:

RAM-B-138-UN10
RAM® X-Grip® Large Phone Mount with Drill-Down Base

FEATURES

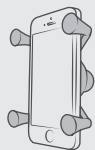

Spring-loaded 'X' design with rubber caps provides a secure fit



Leaves buttons and posts exposed and accessible



Includes safety tether for extra peace of mind

PHONE MOUNTS

RAM® X-GRIP®

The RAM® X-Grip® is the most durable universal phone holder on the market. The spring-loaded arms expand and contract to provide a perfect fit for your phone with or without a case. Available for phones of all sizes, the RAM® X-Grip® cradle secures your device while keeping it completely functional and accessible. No matter what mounting base you pair the RAM® X-Grip® with, the RAM® ball and socket technology allows for near-infinite adjustability and extends the life of your phone with vibration damping capabilities.



RAM-HOL-UN7B
Small Phone Holder



RAM-HOL-UN10B
Large Phone Holder



WATER PROOF



FAST CHARGE



RAM-HOL-UN12WB
Wireless RAM® Tough-Charge™

POPULAR MOUNTS



RAM-B-177-UN7U
Glare Shield Clamp Mount



RAM-B-299-4-UN7U
RAM® Stubby™ Cup Holder Mount



RAM-B-400-HOL-UN7BU
RAM® Tough-Claw™ Rail Mount



RAM-B-166-UN12W
RAM® Twist-Lock™ Suction Cup Mount



SEEN IN THIS PHOTO:

RAM-HOL-PD4-238A

RAM® Quick-Grip™ XL Phone Holder with Ball

RAM-B-201

RAM® Double Socket Arm

RAP-B-354-TRA1

RAM® Track Ball™ with T-Bolt Attachment

RAM® QUICK-GRIP™

Capable of holding a broad range of electronics, the spring-loaded grips provide a secure fit for your phone with or without a case. Take advantage of efficient one-handed placement and removal of your device no matter if the device is in portrait, or landscape. The adjustable side support arms add extra security and can shift to fit the width of your device perfectly. Available for standard size phones and larger models.

FEATURES

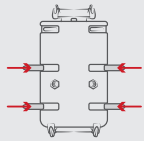

Adjustable side supports for wider devices

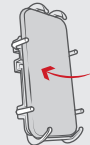

Spring-loaded top grip keeps device in place

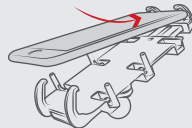

One-handed docking and removal



RAM-HOL-PD3-238A
Small Phone Holder



WATER PROOF



FAST CHARGE



RAM-HOL-UN14WB
Wireless RAM® Quick-Grip™



RAM-HOL-PD4-238A
Large Phone Holder

POPULAR MOUNTS

BEST SELLER



RAM-B-138-PD4U
Drill-down Mount



RAM-B-166-PD3
RAM® Twist-Lock™ Suction Cup Mount



RAM-B-149Z-A-PD3
U-Bolt Rail Mount



WATER PROOF



FAST CHARGE



RAM-B-400-A-UN14W-V7M
RAM® Tough-Claw™ Rail Mount



DID YOU **KNOW**

RAM® Wireless Chargers come with a waterproof silicone sleeve that fits over the USB cable, keeping your USB connection safe and secure.

SEEN IN THIS PHOTO:

RAM-B-400-A-UN12W-V7M

RAM® Tough-Charge™ Waterproof Wireless Charging Mount with Tough-Claw™



WIRELESS CHARGING HOLDERS

The RAM® Tough-Charge™ with X-Grip® Technology and RAM® Quick-Grip™ Wireless are the world's first patented, universal waterproof wireless charging cradles for smartphones. Designed with spring-loaded technology, utilize the best parts of both the RAM® X-Grip® and RAM® Quick-Grip™ phone holders while pairing any smartphone with wireless charging capabilities. For added security and peace of mind, a safety tether is included that's recommended for outdoor applications. Available in a variety of mounting kits, ensure wireless charging capabilities across a wide range of vehicles.

FEATURES



WATER PROOF

Sealed and safe for on water use



FAST CHARGE

Qi Compatible
Charging up to 10W

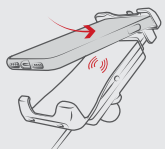

RAM® Quick-Grip™ allows for one-handed docking

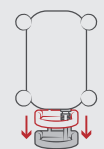

RAM® Tough-Charge™ includes adjustable support leg



RAM-B-400-A-UN14W-V7M

RAM® Quick-Grip™ Waterproof Wireless Charging Mount with Tough-Claw™



BEST SELLER

RAM-B-400-A-UN12W-V7M

RAM® Tough-Charge™ Waterproof Wireless Charging Mount with Tough-Claw™



BUILD YOUR PHONE MOUNT

Keep your phone secured while out on the water with RAM® mounting solutions. Choose from a selection of holders, socket arms and ball bases to build a custom mount for your specific needs. Additional bases may be chosen so that your mount can support multiple devices, or can be transferred to alternate mounting locations.

- 1 CHOOSE A HOLDER**
RAM® offers a wide selection of holders for your specific device.
- 2 CHOOSE AN ARM**
Select an arm based on your desired length and placement.
- 3 CHOOSE A BASE**
Select from a variety of bases to help secure your device where you need it.



HOLDERS



RAM-HOL-UN7B
RAM® X-Grip® for Small Phones



RAM-HOL-UN10B
RAM® X-Grip® for Large Phones



WATER PROOF



FAST CHARGE



RAM-HOL-UN12WB
Wireless RAM® Tough-Charge™ with X-Grip® Technology



WATER PROOF



FAST CHARGE



RAM-HOL-UN14WB
Wireless RAM® Quick-Grip™



RAM-HOL-PD3-238A
RAM® Quick-Grip™ Holder



RAM-HOL-PD4-238A
RAM® Quick-Grip™ XL Holder

2 SOCKET ARMS



RAM-B-201-A
2.42" Short Socket Arm



RAM-B-201
3.73" Medium Socket Arm



RAM-B-201-C
6" Long Socket Arm

3 BASES



RAM-B-378
RAM® Flex Adhesive Ball Base



RAM-B-202U
RAM® Round Drill-Down Base



RAM-B-238
RAM® Diamond Drill-Down Base



RAM-B-224-1
RAM® Twist-Lock™ Suction Cup Base with Ball



RAM-B-400
RAM® Tough-Claw™ Small Clamp Base with Ball



BEST SELLER
RAM-B-354-TRA1
RAM® Track Ball™ with T-Bolt Attachment

MORE COMPONENTS AVAILABLE AT RAMMOUNT.COM/COMPONENTS



SEEN IN THIS PHOTO:

RAM-HOL-AP17U
RAM® EZ-Roll'r™ Cradle

RAM-B-101-C
Drill-Down Mount with long arm

TABLET MOUNTS

Using a tablet with fishing apps and navigation is a viable option made easier by RAM® Mounts utilizing the RAM® Tab-Tite™, EZ-Roll'r™ and X-Grip® holders. Pair with a wide variety of mounting bases and socket arms designed for boating in fresh water and salt water. Each tablet holder is designed to fit your specific need, combined with the modularity of RAM® Mounts components makes these mounts ideal for any tablet you may own used for fishing or recreation. RAM® Mounts knows you need to trust that these expensive tablets out on the water need proper security, so that's why we've ensured that each tablet holder is more than capable of handling the harshest environments.

FEATURES

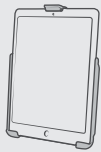

RAM® EZ-Roll'r™ provides form-fit to a specific caseless tablet

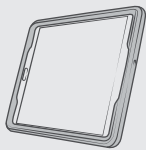

Designed to fit most tablet with and without heavy duty cases

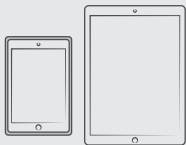

RAM® X-Grip® available for tablets of all sizes



RAM-HOL-AP23U

RAM® EZ-Roll'r™ Cradle for the Apple iPad Pro 11"



RAM-HOL-TAB20U

RAM® Tab-Tite™ Holder for 9" Tablets with Heavy Duty Cases



RAM-HOL-UN8BCU

RAM® X-Grip® Universal Holder for 7"-8" Tablets with Ball



RAM-HOL-UN9U

RAM® X-Grip® Universal Holder for 9"-10" Tablets



BUILD YOUR TABLET MOUNT

RAM® Mounts offer mounting solutions for nearly any tablet. Ideal for your boat, kayak or any other vehicle, RAM® tablet mounts are engineered and manufactured to the highest standards for use in the most rugged environments. Pair any form-fit, RAM® Tab-Tite™ or RAM® X-Grip® holder with any Ball & Socket Mount to build a custom solution to meet your needs.

- 1 CHOOSE A HOLDER**
RAM® offers a wide selection of holders for your specific device.
- 2 CHOOSE A MOUNT**
Select from a variety of mounts to help secure your device where you need it.



1 HOLDERS

RAM® TAB-TITE™



RAM-HOL-TAB6
For 9" Tablets Without Case



RAM-HOL-TAB20U
For 9" Tablets With Case



RAM-HOL-TAB28U
For 9"-10" Tablets Without Case



RAM-HOL-TAB17U
For 9"-10" Tablets With Case

FORM-FIT HOLDERS



RAM-HOL-AP20U
For iPad mini 4 & 5



RAM-HOL-AP22U
For iPad Air 3 & iPad Pro 10.5
2nd Gen



RAM-HOL-AP23U
For iPad Pro 11" 1st & 2nd Gen



RAM-HOL-AP31U
For iPad 7th Gen

1 HOLDERS
RAM® X-GRIP®



RAM-HOL-UN8BCU
For 7"-8" Tablets



RAM-HOL-UN9U
For 9"-10" Tablets

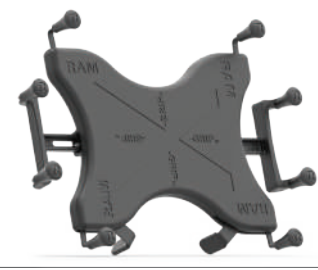

RAM-HOL-UN11U
For 11"-12" Tablets

2 MOUNTS



RAM-101U-B
RAM® Universal Double Ball Mount with Two Round Plates



RAM-101
RAM® Double Ball Mount with Two Round Plates



BEST SELLER

RAM-101U-D
RAM® Double Ball Mount with Two Round Plates



RAM-101U-B-235
RAM® Double U-Bolt Rail Mount for Smaller Rails



RAM-101U-235-1
RAM® Double U-Bolt Rail Mount for Larger Rails



RAM-101U-235
RAM® Double U-Bolt Rail Mount for Smaller Rails



RAM-202-B-400
RAM® Tough-Claw™ Small Clamp Mount with Round Plate Adapter



RAM-202-400
RAM® Tough-Claw™ Small Clamp Mount with Round Plate Adapter



RAP-404-202U
RAM® Tough-Claw™ Medium Clamp Double Ball Mount with Round Plate



RAP-401-202U
RAM® Tough-Claw™ Large Clamp Double Ball Mount with Round Plate



RAM-109V-3U
RAM® Vertical 6" Swing Arm Mount with Swivel Ball & Socket Joint



RAM-109H-3U
RAM® Horizontal 6" Swing Arm Mount with Swivel Ball & Socket Joint

MORE TABLET MOUNTS AVAILABLE AT RAMMOUNT.COM/TABLET

DID YOU **KNOW**

RAM® offers hundreds of interchangeable ball & socket components, allowing you to mount your camera virtually anywhere.

SEEN IN THIS PHOTO:

RAP-B-202-GOP1-354-TRA1

RAM® Track Ball™ Universal Action Camera Mount



GOPRO ADAPTER ACTION CAMERA MOUNTS

Grip 'N Grin culture is strong among anglers in a kayak or boat. Don't miss a moment—replace the factory mounting bracket of your favorite action camera with the RAM® Universal GoPro Adapter and document the catch. The rubber ball design dampens shock and vibration to help extend the life of your camera while getting a smooth shot. Take advantage of RAM® mounting solutions like extension poles as well as suction cup and U-bolt bases for nearly any mounting location on any vessel.

FEATURES

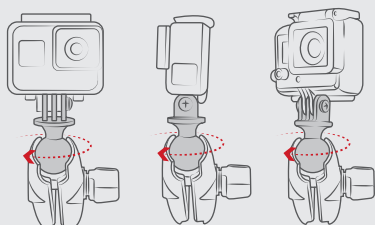

Position your camera at the perfect angle with the turn of a single knob

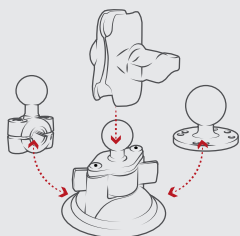

Lightweight and low-profile options

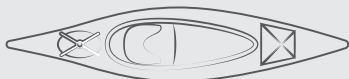

Mountable in nearly any location



RAM-B-166-A-GOP1

RAM® Twist-Lock™ Suction Cup Mount with Universal Action Camera Adapter



**BEST
SELLER**

RAP-B-400-GOP1

RAM® Tough-Claw™ Double Ball Mount with Universal Action Camera Adapter



RAP-B-GOP2-A-GOP1

RAM® Ball Adapter for GoPro® Bases with Universal Action Camera Adapter



RAP-B-202-GOP1

RAM® Action Camera Universal Ball Adapter



SEEN IN THIS PHOTO:

RAP-411-18-A-GOP1

RAM® Tough-Pole™ 24" Camera Mount
with Single Pipe & Dual Track Base

RAM® TOUGH-POLE™ ACTION CAMERA MOUNTS

ACTION CAMERA MOUNTS

Get the ideal angle of your catch with RAM® Tough-Pole™ Action Camera Mounts. Designed to adjust to your desired length, these action camera mounts pair with a variety of mounting bases such as tracks, plungers, flat surfaces and more to provide a versatile camera setup without getting in the way of your fishing or paddling. Each RAM® Tough-Pole™ configuration is equipped with easy-to-assemble components providing a hassle-free mounting solution. Take advantage of the pole extensions and the wide angle lens of the action cameras so you can capture your entire experience.

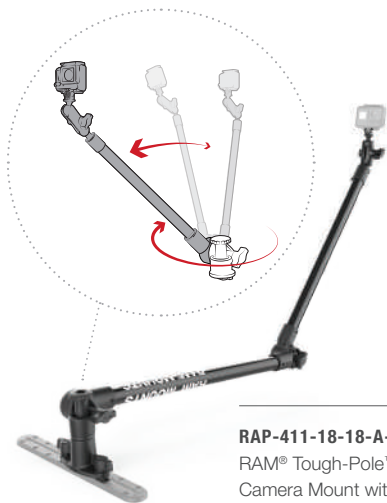

RAP-411-18-18-A-GOP1
RAM® Tough-Pole™ 48"
Camera Mount with Double
Pipe & Dual Track Base



RAP-385-12-18-A-GOP1
RAM® Tough-Pole™ 24" Camera
Mount with
RAM® Press-N-Lock™ Base



RAP-114BD-4-12-A-GOP1
RAM® Tough-Pole™ 29"
Camera Mount with
Bulkhead Base

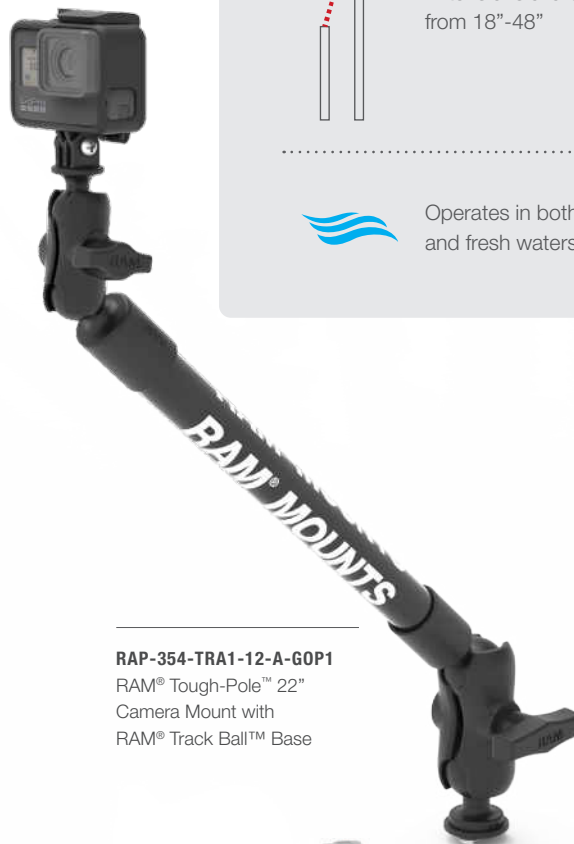

RAP-354-TRA1-12-A-GOP1
RAM® Tough-Pole™ 22"
Camera Mount with
RAM® Track Ball™ Base

FEATURES

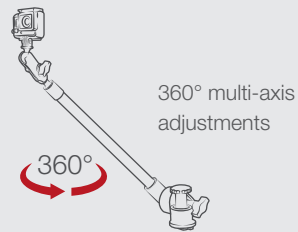

360° multi-axis
adjustments

18" - 48"

Extensions available
from 18" - 48"



Operates in both salt
and fresh waters



DID YOU **KNOW**

The RAM® Finger-Grip™ was the original universal phone holder, before the RAM® X-Grip® and RAM® Quick-Grip™ existed. However, since this holder can accommodate much thicker devices, the RAM® Finger-Grip™ is still a perfect solution for supporting GPS units and handheld radios.

SEEN IN THIS PHOTO:

RAM-HOL-UN4

RAM® Finger-Grip™ Universal Phone and Radio Holder

RAP-B-400-238

RAM® Tough-Claw™ Small Clamp Mount with Diamond Plate Base



FEATURES

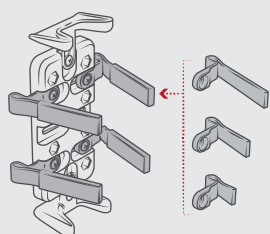

Different finger sizes to accommodate different device thicknesses



Multiple slotted holes to accommodate buttons and ports

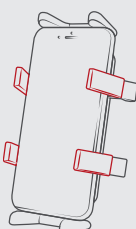

Rubber caps to create friction and firm grip against device

GPS & RADIO MOUNTS

RAM® Mounts offers GPS and radio mounting solutions capable of transferring between your vehicle to your vessel, allowing you to navigate safely and hands-free. From form-fit device mounts such as the RAM® EZ-Roll'r™ cradles for SPOT X, the Garmin Spine Clip to universal options utilizing the RAM® Finger-Grip™, RAM® has you covered across a wide range of devices. Compatible with top top brands including Garmin, SPOT, Midland, Baofeng and more.



RAM-HOL-UN4
RAM® Finger-Grip™ Universal Phone and Radio Holder



RAM-HOL-SP05U
RAM® EZ-Roll'r™ Cradle for SPOT X™



RAM-HOL-GA41
RAM® Form-Fit Cradle for Garmin Astro 320, GPSMAP 62 & 64 Series



RAM-B-202-GA76
RAM® Spine Clip Holder with Ball for Garmin Handheld Devices

DID YOU **KNOW**

If you want to transfer your Fishfinder to multiple mounting locations, you can have multiple drill-down ball bases installed at various locations. You can even transfer from Kayak to Boat.

SEEN IN THIS PHOTO:

RAM-111

Drill-Down Mount

RAP-403

Cable Manager



ACCESSORIES & MORE

FISHFINDER MOUNT ACCESSORIES

Mounting to your boat can be tricky. You don't want to put holes in the wrong areas. Mount your base in the best, most secure locations using our RAM® Mari-Nut and Mari-Rivet mounting hardware paired with the RAM® cable manager; perfect for your fishfinder. The RAM® Cable manager acts as a mounting platform for your ball base as well as a neat and organized way of feeding the fishfinder cables through to avoid snags and tangles. Between the large and small sizes, these cable managers are designed to fit bundled cords from any fishfinder, perfectly.



RAP-402
RAM® Cable Manager for D Size Fishfinder Mounts



RAP-403
RAM® Cable Manager for B Size and C Size Fishfinder Mounts



RAM-MARI-RIVET-4
RAM® Mari-Rivet™ Aluminum Pop Rivet



RAM-MARI-NUT-4
RAM® Mari-Nut™ Rubber Expansion Mounting Hardware

SEEN IN THIS PHOTO:

RAM-D-111-C

Drill-Down Mount for Marine
Electronics

RAM-KNOB9H

RAM® Hi-Torq™ Wrench

TORQUE WRENCH / LOCKING KNOBS

Security is a big focus area for RAM® Mounts—that’s why locking accessories are available for all socket arms and swing arm mounts. Designed with patented locking patterns, these locking knobs are swappable with the standard RAM® knob to convert your mount for theft deterrence. Additionally, the RAM® Hi-Torq™ Wrench is used to tighten the mount into place when mounting a heavy duty fishfinder. Handling and adjusting the position of all that extra weight can be made easy with this handy tool. Explore more fishfinder mount accessories on the next page.



RAM-KNOB9H
RAM® Hi-Torq™ Wrench for D
Size Socket Arms

FEATURES

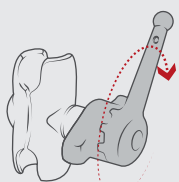

RAM® Hi-Torq™
Wrench ensures
the tightest fit



Locking accessories for
mounts and factory
gimbal brackets



All locking accessories
built for theft deterrence
and removal



RAP-S-KNOB5
RAM® Pin-Lock™ Security Knob
for C Size Socket Arms



RAP-S-NUT5
RAM® Pin-Lock™ Security Nut
for D Socket Arms



RAP-S-KNOBG-109
RAM® Pin-Lock™ Security Kit
for Single Swing Arms and
Gimbal Brackets



RAP-S-KNOBG-109-1
RAM® Pin-Lock™ Security Kit for
Double Swing Arms and
Gimbal Brackets

SEEN IN THIS PHOTO:

RAM-B-166-GOP1

RAM® Twist-Lock™ Suction Cup Mount
with Universal Action Camera Adapter



FEATURES

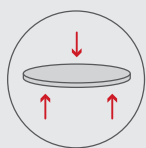

Slip-free mounting options



Lightweight design to maintain balance



Leash plug adapter options

PADDLEBOARD MOUNTS

Paddleboards need mounts too! RAM® Mounts utilizes phone holders and action camera mounts with RAM® components to create ideal paddleboard mounts; designed to fit securely on a wet, flat surface, these kits provide mounting options for any paddleboard, for any situation. Between flat surface mounting options that do not require drilling into the board, to leash plug adapters, these mounts are all you need to mount your desired device.



RAP-B-378-UN7

RAM® X-Grip® Phone Mount with Flex Adhesive Base



RAP-B-166-GOP1

RAM® Twist-Lock™ Composite Suction Mount with Action Camera Adapter



RAP-B-224-1

RAM® Twist-Lock™ Composite Suction Cup Base with Ball



RAP-B-378

RAM® Flex Adhesive Ball Base



RAP-350-35B

RAM® Black 3.5" Adhesive Plate for Suction Cups



RAP-B-379U-M81208

RAM® Tough-Ball™ for Red Paddle Boards



RAP-430-224

RAM® Tough-Clip™ Paddle Cradle with Double RAM® Twist-Lock™ Suction Cup



RAP-B-405U

RAM® Leash Plug Ball Adapter



RAP-406U

RAM® Leash Cup



SEEN IN THIS PHOTO:

RAP-340NB

RAM ROD® 2007 Fishing Rod Holder

RAP-399U

Float Tube Adapter with Strap and 1.5" Ball

INFLATABLE CRAFTS MOUNTS

RAM® offers easy-to-install mounting bases for inflatable and pontoon-style watercrafts. Pair any compatible RAM® components to these bases to create mounting solutions for consumer devices, fishing rod holders, fishfinder mounts and more. Our revolutionary RAM® Bond-A-Base™ provides a strong adhesive to install on most smooth surfaces and a versatile mounting surface capable of installing a track or drill-down system depending on your desired configuration. Each mounting base is designed to avoid any damage caused to the inflatables by eliminating the need to drill into part of the vessel.



FEATURES



No-drill flex adhesive and strap bases to eliminate damage to the vessel

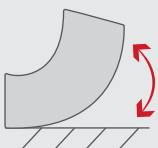

Flex adhesive bases provide mountable area for a variety of RAM® bases



Easy and quick to install

**BEST
SELLER**

RAP-398-BLK-114BMPU

RAM® Bond-A-Base™ Black Adhesive Base with RAM ROD® Post/Spline Receiver



RAP-398-GRY-202U

RAM® Bond-A-Base™ Adhesive Base with Ball



RAP-399U

RAM® Float Tube Strap Adapter Ball Base



RAP-398-GRY-TRACK-A

RAM® Bond-A-Base™ Adhesive Base with RAM® Tough-Track™



DID YOU **KNOW**

Comfort and safety are always important factors considered in RAM® product designs. All RAM® Tough-Tracks™ are designed specifically without any sharp edges. Smooth, round edges on all track corners make it impossible to scratch or snag your clothes/gear.

SEEN IN THIS PHOTO:

RAP-434-421

RAM ROD® JR Fishing Rod Holder
with Dual T-Bolt Track Base



RAM® TOUGH-TRACK™

When it comes to track mounting systems, RAM® Mounts easily has the competition beat. From a wide variety of lengths and track styles to choose from, RAM® Tough-Tracks™ are fully customizable solutions with thousands of configurations. Able to support multiple devices, RAM® Tough-Tracks™ are designed to handle specific weights, number of devices and mounting locations. Take advantage of the modular aluminum tracks that include connector pieces in order to extend the length of the track system and create corners for multi-directional mounting. Not interested in drilling into your vessel? RAM® offers hand tracks and rail mounted tracks for easy install and removal of the entire system. Explore the whole line of track mounting systems below or check them out on the RAM® website.



MODULAR ALUMINUM

FEATURES



High strength materials support multiple-device mounting

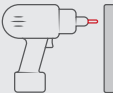

Drill to any flat surface with #8 screws

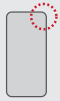

No sharp edges

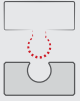

Modular track extensions for additional length



Low-profile design



■ **RAM-TRACK-EXA-3**
3" Modular Aluminum
RAM® Tough-Track™

■ **RAM-TRACK-EXA-5**
5" Modular Aluminum
RAM® Tough-Track™

■ **RAM-TRACK-EXA-9**
9" Modular Aluminum
RAM® Tough-Track™

■ **RAM-TRACK-EXA-13**
13" Modular Aluminum
RAM® Tough-Track™

■ **RAM-TRACK-EXA-17**
17" Modular Aluminum
RAM® Tough-Track™

■ **RAM-TRACK-EXA-3BU**
3" Modular Aluminum
Black RAM®
Tough-Track™

■ **RAM-TRACK-EXA-5BU**
5" Modular Aluminum
Black RAM®
Tough-Track™

■ **RAM-TRACK-EXA-9BU**
9" Modular Aluminum
Black RAM®
Tough-Track™

■ **RAM-TRACK-EXA-13BU**
13" Modular Aluminum
Black RAM®
Tough-Track™

■ **RAM-TRACK-EXA-17BU**
17" Modular Aluminum
Black RAM®
Tough-Track™

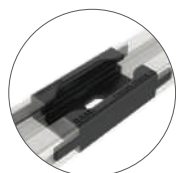

■ **RAP-TRACK-EXA-CCU**
RAM® Center Connector
for Modular Aluminum
RAM® Tough-Track™

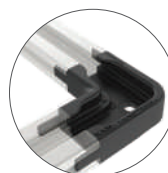

■ **RAP-TRACK-EXA-CC90U**
RAM® 90-Degree Connector
for Modular Aluminum
RAM® Tough-Track™



SEEN IN THIS PHOTO:

RAP-TRACK-A5

Top-Loading Composite RAM® Tough-Track™

RAP-B-202-GOP1-354-TRA1

RAM® Track Ball™ with Action Camera

TOP-LOADING COMPOSITE

FEATURES



High strength materials support multiple-device mounting

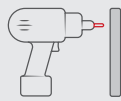

Drill to any flat surface with #10 screws



No sharp edges



Mounting holes are outside the track for reinforced stability



Low-profile design



RAP-TRACK-A2
RAM® Tough-Track™
- Top-Loading
Composite 2.43" Track



RAP-TRACK-A3
RAM® Tough-Track™
- Top-Loading
Composite 3" Track



RAP-TRACK-A5
RAM® Tough-Track™
- Top-Loading
Composite 5" Track



RAP-TRACK-A9
RAM® Tough-Track™
- Top-Loading
Composite 9" Track



RAP-TRACK-A12
RAM® Tough-Track™
- Top-Loading
Composite 12" Track



RAP-TRACK-A16
RAM® Tough-Track™
- Top-Loading
Composite 16" Track

RAM® HAND-TRACK™

FEATURES



High strength materials support multiple-device mounting

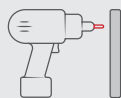

Drill to any flat surface with #10 screws



No sharp edges

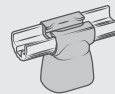

Compatible with RAM® Hand-Track™ extensions



Low-profile design

**BEST
SELLER**



RAM-TRACK-H4
4" RAM® Hand-Track™ with 10"
Overall Length



RAM-TRACK-H6
6" RAM® Hand-Track™ with
12" Overall Length



RAM-TRACK-H8
8" RAM® Hand-Track™ with
14" Overall Length



RAM-TRACK-H10
10" RAM® Hand-Track™ with
16" Overall Length



RAM-TRACK-H12
12" RAM® Hand-Track™ with
18" Overall Length



RAM-TRACK-H15
15" RAM® Hand-Track™
with 21" Overall Length



RAM-TRACK-H18
18" RAM® Hand-Track™
with 24" Overall Length



RAM-TRACK-H30
30" RAM® Hand-Track™
with 36" Overall Length



RAM-TRACK-HC-6
RAM® Hand-Track™
Center Connector with 6"
Track Extension



SEEN IN THIS PHOTO:

RAP-412-2

RAM® Roller-Ball™ 2-Pack



SEEN IN THIS PHOTO:

RAM-TRACK-EXA-5

5" Modular Aluminum RAM® Tough-Track™

RAP-TRACK-EXA-CCU

Center Connector for Modular Aluminum
RAM® Tough-Track™

RAP-412

RAM® Roller-Ball™



PADDLE HOLDERS

When paddles aren't in use, take advantage of the RAM® Roller-Ball™ to keep your paddle secured in place. Simply press the paddle into the RAM® Roller-Ball™ bases to lock into place. Once you're ready move locations, lift the paddle up and out to regain your mobility—easy!

FEATURES



Flexible rolling ball design allows for an easy one-handed docking and removal

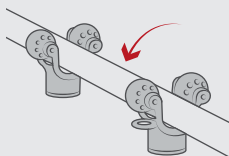

Strong tension arms to hold paddle in place



Attachment points for security cables for extra peace of mind



RAP-412

RAM® Roller-Ball™ Paddle & Accessory Holder



RAP-430TD

RAM® Tough-Clip™ Paddle Cradle with Track bolts and Drill-Down Hardware

DID YOU **KNOW**

RAM® Cup Holder mounts are a fan favorite for use on ATV's, boats, motorcycles, wheelchairs, music stands, and much more.

SEEN IN THIS PHOTO:

RAP-B-417-400

RAM® Tough-Claw™ mount
for beverage container

CUP HOLDER MOUNTS

Grab your Yeti and head out on the water! No place to hold your drink while you drive the boat or paddle your kayak? No worries—RAM® Mounts makes self-leveling cup holder mounts compatible with RAM components so you can mount your drink anywhere you want and trust that it won't fall into the water. Don't let your precious coffee spill, RAM® offers cup holders for 16oz and 32oz with plenty of support in case you're charting harsh waters.

FEATURES



Self-leveling swivel mount prevents spills

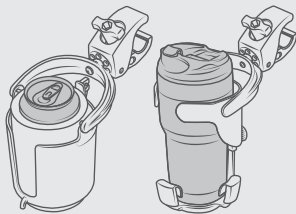

16oz or 32oz drink compatibility



Height adjusts for 32oz holder



RAM-B-132-400

RAM® Level Cup™ 16oz Drink Holder with RAM® Tough-Claw™ Mount



RAM-B-417B-C-354-TRA1

RAM® Level Cup™ XL 32oz Drink Holder with RAM® Track Ball™ Base

**BEST
SELLER**



RAP-B-417-400

RAM® Level Cup™ XL 32oz Drink Holder with RAM® Tough-Claw™



RAP-B-417B

RAM® Level Cup™ XL 32oz Drink Holder with Ball





SEEN IN THIS PHOTO:

RAP-400-202

RAM® Tough-Claw™

Trolling Motor Stabilizer

TROLLING MOTOR STABILIZERS

The RAM® Tough-Claw™ is the perfect mounting base for quick and easy tool-less installation and removal on round, square, odd shaped rails and bars. The RAM® Tough-Claw™ can be converted into the most versatile mounting option for motor stabilizers. Simply tighten the grip of the RAM® Tough-Claw™ attached to the motor stabilizer and attach the drill-down base to the most effective location on the vessel to achieve the perfect mount.

FEATURES

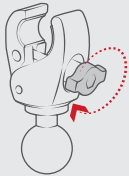

RAM® Tough-Claw™ ensures strongest hold

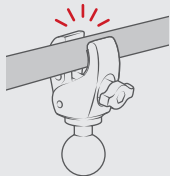

Easily adjust positions by simply loosening grip

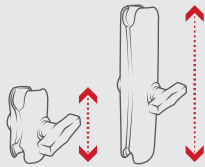

Multi-length socket arms for desired height



**BEST
SELLER**

RAP-400-202
RAM® Tough-Claw™
Trolling Motor Stabilizer



RAP-400
RAM® Tough-Claw™ Small Clamp Ball Base



RAM-108B
RAM® Strap Hose Clamp Base



RAM-108
RAM® Trolling Motor Stabilizer with Strap
Hose Clamp



SEEN IN THIS PHOTO:

RAP-398-BLK-TRACK-A

RAM® Bond-A-Base™ with RAM® Tough-Track™

RAP-B-202-GOP1-354-TRA1

RAM® Track Ball™ with Action Camera Adapter

RAP-432

RAM® Tough-Cleat™

SECURITY MOUNTS

TOUGH-CLEAT / TIE-DOWNS / ANCHOR LINE

Tie-downs are critical on kayaks, and RAM® Mounts supplies strong track-based components that are easy to use and compatible with RAM® Tough-Tracks™ and most third party track systems. Keeping the versatility of the RAM® Mount system, these crucial mounts are designed to be easy to remove and install while providing a strong hold worthy of securing your supplies. Paired with a lifetime warranty, these tie-down mounts are a must-have add-on for any kayak.



RAP-432

RAM® Tough-Cleat™ Anchor Tie-Off with Track Adapter

FEATURES

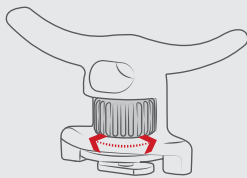

Twist knob to tighten and loosen from track

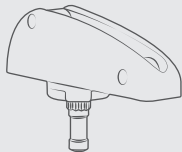

Anchor line mount compatible with post & spline systems

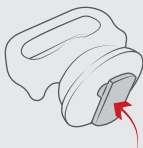

All tie-downs equipped with t-bolts for track mounting



RAP-357P

RAM® Anchor Line Lock with Post



RAP-431

RAM® 2-Pack Vertical Tie Down Track Accessory

DID YOU **KNOW**

The LED Bulb in this spotlight is replaceable. RAM® offers replacement LED bulbs, or you can replace with any 3rd party PAR36 bulb.



SEEN IN THIS PHOTO:

RAM-B-152-404

RAM® Tough-Claw™ Mount with LED Spotlight

SPOTLIGHT MOUNTS

Fishing at night? RAM® makes all-in-one mounting solutions for LED spotlights and a variety of mounting bases to install anywhere on the vessel. The waterproof casing around the light source is all in one piece and can easily be removed to replace the bulb. A pre-installed RAM® ball ensures these spotlights are compatible with all B size components in order to create your own custom mount for your desired location and positioning.

FEATURES



**WATER
PROOF**

All-in-one waterproof
rubber housing



Compatible with any third party
PAR36 LED bulb



Built-in 10' extension cord



RAM-B-152-404

RAM® Tough-Claw™ Double Ball
Mount with LED Spotlight



RAM-B-152-231Z-2

Strap Hose Clamp Mount with
LED Spotlight

PRODUCT CHARTS & COMPATIBILITY



KAYAKING FISHFINDER COMPATIBILITY

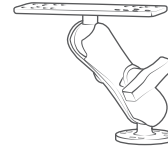
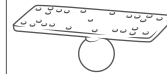
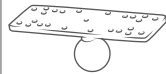

MAKE	MODEL	BALL ADAPTER	DOUBLE BALL MOUNT
Garmin	GPSMAP 7607 / xsv	RAM-111BU	"111" Series
	GPSMAP 7407 / xsv	RAM-111BU	"111" Series
	GPSMAP 7608 / xsv	RAM-111BU	"111" Series
	GPSMAP 7408 / xsv	RAM-111BU	"111" Series
	GPSMAP 742 / xs Plus	RAM-111BU	"111" Series
	GPSMAP 722 / xs Plus	RAM-111BU	"111" Series
	GPSMAP 942 / xs Plus	RAM-111BU	"111" Series
	GPSMAP 922 / xs Plus	RAM-111BU	"111" Series
	Echomap Plus 42cv	RAM-B-202-G4U	RAM-B-101-G4 (See Custom mounts)
	Echomap Plus 43cv	RAM-B-202-G4U	RAM-B-101-G4 (See Custom mounts)
	Echomap Plus 44cv	RAM-B-202-G4U	RAM-B-101-G4 (See Custom mounts)
	Echomap Plus 45cv	RAM-B-202-G4U	RAM-B-101-G4 (See Custom mounts)
	Echomap UHD 62cv	RAM-111BU	"111" Series
	Echomap UHD 63cv	RAM-111BU	"111" Series
	Echomap UHD 64cv	RAM-111BU	"111" Series
	Echomap UHD 65cv	RAM-111BU	"111" Series
	Echomap UHD 72sv	RAM-111BU	"111" Series
	Echomap UHD 73sv	RAM-111BU	"111" Series
	Echomap UHD 74sv	RAM-111BU	"111" Series
	Echomap UHD 75sv	RAM-111BU	"111" Series
	Echomap UHD 92sv	RAM-111BU	"111" Series
	Echomap UHD 93sv	RAM-111BU	"111" Series
	Echomap UHD 94sv	RAM-111BU	"111" Series
	Echomap UHD 95sv	RAM-111BU	"111" Series
	Echomap Plus 62cv	RAM-111BU	"111" Series
	Echomap Plus 63cv	RAM-111BU	"111" Series
	Echomap Plus 64cv	RAM-111BU	"111" Series
	Echomap Plus 65cv	RAM-111BU	"111" Series
	Echomap Plus 72sv	RAM-111BU	"111" Series
	Echomap Plus 73sv	RAM-111BU	"111" Series
	Echomap Plus 74sv	RAM-111BU	"111" Series
	Echomap Plus 75sv	RAM-111BU	"111" Series
	Echomap Plus 77sv	RAM-111BU	"111" Series
	Echomap Plus 92sv	RAM-111BU	"111" Series
	Echomap Plus 93sv	RAM-111BU	"111" Series
	Echomap Plus 94sv	RAM-111BU	"111" Series
	Echomap Plus 95sv	RAM-111BU	"111" Series
	Echomap Plus 97sv	RAM-111BU	"111" Series
	echoMAP CHIRP 43cv	RAM-B-202-G4U	RAM-B-101-G4 (See Custom mounts)
	echoMAP CHIRP 73cv	RAM-111BU	"111" Series
	echoMAP CHIRP 74cv	RAM-111BU	"111" Series
	echoMAP CHIRP 75cv	RAM-111BU	"111" Series
	echoMAP CHIRP 74sv	RAM-111BU	"111" Series
	echoMAP CHIRP 94sv	RAM-111BU	"111" Series
	echoMAP CHIRP 93sv	RAM-111BU	"111" Series
STRIKER Plus 4	RAM-B-202-G4U	RAM-B-101-G4 (See Custom mounts)	
STRIKER Plus 4cv	RAM-B-202-G4U	RAM-B-101-G4 (See Custom mounts)	
STRIKER Plus 5cv	RAM-B-111BU	"B-111" Series	
STRIKER Plus 7cv	RAM-111BU	"111" Series	
STRIKER Plus 7sv	RAM-111BU	"111" Series	
STRIKER Plus 9sv	RAM-111BU	"111" Series	
STRIKER 4	RAM-B-202-G4U	RAM-B-101-G4 (See Custom mounts)	

MAKE	MODEL	BALL ADAPTER	DOUBLE BALL MOUNT
Humminbird	Helix 5	RAM-202U-153	RAM-202-153-202U (See Custom mounts)
	Helix 7	RAM-202U-24	RAM-202-24-202U (See Custom Mounts)
	Helix 8	RAM-111BU	"111" Series
	Helix 9	RAM-111BU	"111" Series
PiranhaMax 4		RAM-B-107-1BU	RAM-B-107-1U (See Custom Mounts)
HOOK Reveal 5		RAM-B-202-LO12	RAM-B-101-LO12 (See Custom Mounts)
HOOK Reveal 7		RAM-111BU	"111" Series
HOOK Reveal 9		RAM-111BU	"111" Series
Lowrance	Elite-7 Ti2	RAM-202U-LO11	RAM-101-LO11 (See Custom Mounts)
Elite-9 Ti2		RAM-111BU	"111" Series
HDS-7 LIVE		RAM-111BU	"111" Series
HDS-9 LIVE		RAM-111BU	"111" Series
Raymarine	Dragonfly 5 Pro	RAP-B-379U-M616	RAM-B-202-379-M616
	Dragonfly 7 Pro	RAP-B-379U-M616	RAM-B-202-379-M616

INTRO
 BOATING MOUNTS
 KAYAK MOUNTS
 DEVICE MOUNTS
 ACCESSORIES & MORE
 PRODUCT CHARTS

BOATING FISHFINDER COMPATIBILITY

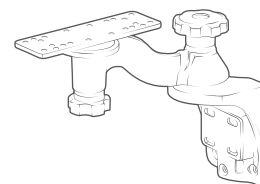
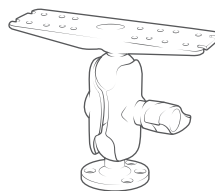
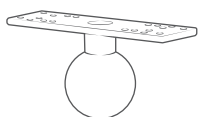

MAKE	MODEL	BALL ADAPTER	DOUBLE BALL MOUNT	SWING ARM MOUNT
Garmin	GPSMAP 8616 / xsv	RAM-D-115BU	"D-115" Series	"109" Series
	GPSMAP 8416 / xsv	RAM-D-115BU	"D-115" Series	"109" Series
	GPSMAP 8610 / xsv	RAM-D-115BU	"D-115" Series	"109" Series
	GPSMAP 8410 / xsv	RAM-D-115BU	"D-115" Series	"109" Series
	GPSMAP 8612 / xsv	RAM-D-115BU	"D-115" Series	"109" Series
	GPSMAP 8412 / xsv	RAM-D-115BU	"D-115" Series	"109" Series
	GPSMAP 7607 / xsv	RAM-111BU	"111" Series	"109" Series
	GPSMAP 7407 / xsv	RAM-111BU	"111" Series	"109" Series
	GPSMAP 7608 / xsv	RAM-111BU	"111" Series	"109" Series
	GPSMAP 7408 / xsv	RAM-111BU	"111" Series	"109" Series
	GPSMAP 7610 / xsv	RAM-D-111BU	"D-111" Series	
	GPSMAP 7410 / xsv	RAM-D-111BU	"D-111" Series	
	GPSMAP 7612 / xsv	RAM-D-111BU	"D-111" Series	
	GPSMAP 7412 / xsv	RAM-D-111BU	"D-111" Series	
	GPSMAP 7616 / xsv	RAM-D-111BU	"D-111" Series	
	GPSMAP 7416 / xsv	RAM-D-111BU	"D-111" Series	
	GPSMAP 742 / xs Plus	RAM-111BU	"111" Series	"109" Series
	GPSMAP 722 / xs Plus	RAM-111BU	"111" Series	"109" Series
	GPSMAP 942 / xs Plus	RAM-D-115BU	"D-115" Series	"109" Series
	GPSMAP 922 / xs Plus	RAM-D-115BU	"D-115" Series	"109" Series
	GPSMAP 1222 / xsv Plus	RAM-D-111BU	"D-111" Series	
	GPSMAP 1242 / xsv Plus	RAM-D-111BU	"D-111" Series	
	GPSMAP 1022	RAM-D-111BU	"D-111" Series	
	GPSMAP 1022xsv	RAM-D-111BU	"D-111" Series	
	GPSMAP 1042xsv	RAM-D-111BU	"D-111" Series	
	GPSMAP 1222	RAM-D-111BU	"D-111" Series	
	GPSMAP 1222xsv	RAM-D-111BU	"D-111" Series	
	GPSMAP 1242xsv	RAM-D-111BU	"D-111" Series	
	Echomap Ultra 102sv	RAM-D-111BU	"D-111" Series	
	Echomap Ultra 106sv	RAM-D-111BU	"D-111" Series	
	Echomap Ultra 122sv	RAM-D-111BU	"D-111" Series	
	Echomap Ultra 126sv	RAM-D-111BU	"D-111" Series	
	Echomap Plus 42cv	RAM-202-G4U	RAM-101-G4 (See Custom mounts)	
	Echomap Plus 43cv	RAM-202-G4U	RAM-101-G4 (See Custom mounts)	
	Echomap Plus 44cv	RAM-202-G4U	RAM-101-G4 (See Custom mounts)	
	Echomap Plus 45cv	RAM-202-G4U	RAM-101-G4 (See Custom mounts)	
	Echomap UHD 62cv	RAM-111BU	"111" Series	"109" Series
	Echomap UHD 63cv	RAM-111BU	"111" Series	"109" Series
	Echomap UHD 64cv	RAM-111BU	"111" Series	"109" Series
	Echomap UHD 65cv	RAM-111BU	"111" Series	"109" Series
Echomap UHD 72sv	RAM-111BU	"111" Series	"109" Series	
Echomap UHD 73sv	RAM-111BU	"111" Series	"109" Series	
Echomap UHD 74sv	RAM-111BU	"111" Series	"109" Series	
Echomap UHD 75sv	RAM-111BU	"111" Series	"109" Series	
Echomap UHD 92sv	RAM-D-115BU	"D-115" Series	"109" Series	
Echomap UHD 93sv	RAM-D-115BU	"D-115" Series	"109" Series	
Echomap UHD 94sv	RAM-D-115BU	"D-115" Series	"109" Series	
Echomap UHD 95sv	RAM-D-115BU	"D-115" Series	"109" Series	
Echomap Plus 62cv	RAM-111BU	"111" Series	"109" Series	
Echomap Plus 63cv	RAM-111BU	"111" Series	"109" Series	
Echomap Plus 64cv	RAM-111BU	"111" Series	"109" Series	
Echomap Plus 65cv	RAM-111BU	"111" Series	"109" Series	
Echomap Plus 72sv	RAM-111BU	"111" Series	"109" Series	
Echomap Plus 73sv	RAM-111BU	"111" Series	"109" Series	
Echomap Plus 74sv	RAM-111BU	"111" Series	"109" Series	
Echomap Plus 75sv	RAM-111BU	"111" Series	"109" Series	

BOATING FISHFINDER COMPATIBILITY

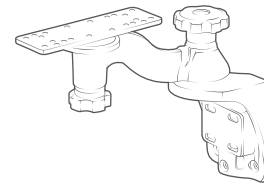
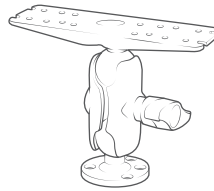
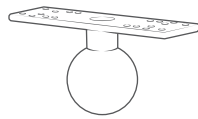

MAKE	MODEL	BALL ADAPTER	DOUBLE BALL MOUNT	SWING ARM MOUNT
Garmin	Echomap Plus 77sv	RAM-111BU	"111" Series	"109" Series
	Echomap Plus 92sv	RAM-D-115BU	"D-115" Series	"109" Series
	Echomap Plus 93sv	RAM-D-115BU	"D-115" Series	"109" Series
	Echomap Plus 94sv	RAM-D-115BU	"D-115" Series	"109" Series
	Echomap Plus 95sv	RAM-D-115BU	"D-115" Series	"109" Series
	Echomap Plus 97sv	RAM-D-115BU	"D-115" Series	"109" Series
	echoMAP CHIRP 43cv	RAM-202-G4U	RAM-101-G4 (See Custom mounts)	
	echoMAP CHIRP 73cv	RAM-111BU	"111" Series	"109" Series
	echoMAP CHIRP 74cv	RAM-111BU	"111" Series	"109" Series
	echoMAP CHIRP 75cv	RAM-111BU	"111" Series	"109" Series
	echoMAP CHIRP 74sv	RAM-111BU	"111" Series	"109" Series
	echoMAP CHIRP 94sv	RAM-D-115BU	"D-115" Series	"109" Series
	echoMAP CHIRP 93sv	RAM-D-115BU	"D-115" Series	"109" Series
	STRIKER Plus 4	RAM-202-G4U	RAM-101-G4 (See Custom mounts)	
	STRIKER Plus 4cv	RAM-202-G4U	RAM-101-G4 (See Custom mounts)	
	STRIKER Plus 5cv	RAM-111BU	"111" Series	"109" Series
	STRIKER Plus 7cv	RAM-111BU	"111" Series	"109" Series
	STRIKER Plus 7sv	RAM-111BU	"111" Series	"109" Series
STRIKER Plus 9sv	RAM-D-115BU	"D-115" Series	"109" Series	
STRIKER 4	RAM-202-G4U	RAM-101-G4 (See Custom mounts)		
Humminbird	Helix 5	RAM-202U-153	RAM-202-153-202U (See Custom mounts)	
	Helix 7	RAM-202U-24	RAM-202-24-202U (See Custom Mounts)	
	Helix 8	RAM-D-202U-25	RAM-D-202-25-C-202U (See Custom Mounts)	"109" Series
	Helix 9	RAM-D-202U-25	RAM-D-202-25-C-202U (See Custom Mounts)	"109" Series
	Helix 10	RAM-D-202U-25	RAM-D-202-25-C-202U (See Custom Mounts)	"109" Series
	PiranhaMax 4	RAM-B-107-1BU	RAM-B-107-1U (See Custom Mounts)	
	Solix 10	RAM-D-202U-25	RAM-D-202-25-C-202U (See Custom Mounts)	"109" Series
	Solix 12	RAM-D-202U-25	RAM-D-202-25-C-202-KNOB9HU (See Custom Mounts)	"109" Series
Solix 15	RAM-D-202U-25	RAM-D-202-25-C-202-KNOB9HU (See Custom Mounts)	"109" Series	
Lowrance	HOOK Reveal 5	RAM-202-LO12	RAM-101-LO12 (See Custom Mounts)	
	HOOK Reveal 7	RAM-111BU	"111" Series	"109" Series
	HOOK Reveal 9	RAM-D-115BU	"D-115" Series	"109" Series
	Elite-7 Ti2	RAM-202U-LO11	RAM-101-LO11 (See Custom Mounts)	RAM-109H-2B-B-LO11
	Elite-9 Ti2	RAM-D-111BU	"D-111" Series	
	Elite-12 Ti2	RAM-D-111BU	"D-111" Series	
	HDS-7 LIVE	RAM-111BU	"111" Series	"109" Series
	HDS-9 LIVE	RAM-D-115BU	"D-115" Series	"109" Series
HDS-12 LIVE	RAM-D-115BU	"D-115" Series	"109" Series	
HDS-16 LIVE	RAM-D-115BU	RAM-D-115-C-KNOB9H	"109" Series	
Raymarine	Dragonfly 5 Pro	RAP-B-379U-M616	RAM-B-202-379-M616	
	Dragonfly 7 Pro	RAP-B-379U-M616	RAM-B-202-379-M616	
	Axiom 7	RAM-D-111BU	"D-111" Series	
	Axiom 9	RAM-D-111BU	"D-111" Series	
	Axiom 12	RAM-D-111BU	"D-111" Series	

FISHFINDER MOUNTS

BALL SIZE SELECTION GUIDE

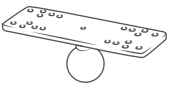
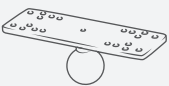
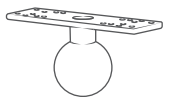
FISHFINDER SCREEN SIZE	VEHICLE TYPE	RECOMMENDED BALL SIZE
 4" - 5" Fishfinders	Kayak	B Size 1"
 4" - 7" Fishfinders	Boat	C Size 1.5"
 up to 9" Fishfinders	Kayak	C Size 1.5"
 8" - 16" Fishfinders	Boat	D Size 2.25"

"B-111" SERIES

B SIZE 1" BALL WITH 6.25" X 2" PLATE

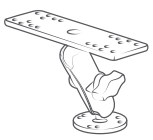
	PART NUMBER	MOUNT FUNCTION	ARM LENGTH	MATERIAL	NOTES
	RAM-B-111B	-	-	-	Marine-Grade Aluminum
RAM-B-111U-A	Drill-Down	Short	Marine-Grade Aluminum	-	
BEST SELLER RAM-B-111	Drill-Down	Medium	Marine-Grade Aluminum	-	
RAM-B-111U-C	Drill-Down	Long	Marine-Grade Aluminum	-	
RAM-B-111-238U	Drill-Down	Medium	Marine-Grade Aluminum	2-Hole Diamond Ball Base	
RAM-S-B-111	Drill-Down	Medium	Marine-Grade Aluminum	RAM® Pin-Lock™ Security Knob Included	
RAM-SG-B-111	Drill-Down	Medium	Marine-Grade Aluminum	RAM® Pin-Lock™ Security Knob & Gimbal Knob Included	
RAP-B-111-A	Drill-Down	Short	High Strength Composite	-	
RAP-B-111	Drill-Down	Medium	High Strength Composite	-	
RAP-B-111B-354-TRA1	Track	Medium	High Strength Composite	-	

"111" SERIES

C SIZE 1.5" BALL WITH 6.25" X 2" PLATE

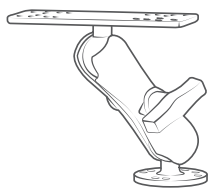
	PART NUMBER	MOUNT FUNCTION	ARM LENGTH	MATERIAL	NOTES
	RAM-111B	-	-	-	Marine-Grade Aluminum
RAM-111-B	Drill-Down	Short	Marine-Grade Aluminum	-	
BEST SELLER RAM-111	Drill-Down	Medium	Marine-Grade Aluminum	-	
RAM-111-D	Drill-Down	Long	Marine-Grade Aluminum	-	
RAM-S-111	Drill-Down	Medium	Marine-Grade Aluminum	RAM® Pin-Lock™ Security Knob Included	
RAM-SG-111	Drill-Down	Medium	Marine-Grade Aluminum	RAM® Pin-Lock™ Security Knob & Gimbal Knob Included	
RAM-111-403U	Drill-Down	Medium	Marine-Grade Aluminum	Cable Manager Included	
RAM-111B-354-TRA1	Track	Medium	Marine-Grade Aluminum	-	
RAP-111	Drill-Down	Medium	High Strength Composite	-	
RAP-111-B	Drill-Down	Short	High Strength Composite	-	

"D-115" SERIES

D SIZE 2.25" BALL WITH 6.25" X 2" PLATE

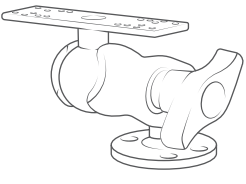
	PART NUMBER	MOUNT FUNCTION	ARM LENGTH	NOTES
	RAM-D-115BU	-	-	-
BEST SELLER RAM-D-115-C	Drill-Down	Short	-	-
RAM-D-115	Drill-Down	Medium	-	-
RAM-D-115-E	Drill-Down	Long	-	-
RAM-D-115-C-KNOB9H*	Drill-Down	Medium	-	RAM® Hi-Torq™ Wrench Included

*RAM® Hi-Torq™ Wrench Required for 16" Fishfinders

FISHFINDER MOUNTS

"D-111" SERIES D SIZE 2.25" BALL WITH 3" X 11" PLATE

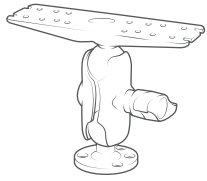

PART NUMBER	MOUNT FUNCTION	ARM LENGTH	NOTES
RAM-D-111BU	-	-	Ball Adapter
BEST SELLER RAM-D-111-C	Drill-Down	Short	-
RAM-D-111	Drill-Down	Medium	-
RAM-D-111U-E	Drill-Down	Long	-
RAM-D-111-C-KNOB9H*	Drill-Down	Short	RAM® Hi-Torq™ Wrench Included
RAM-D-111-KNOB9H*	Drill-Down	Medium	RAM® Hi-Torq™ Wrench Included
RAM-S-D-111	Drill-Down	Medium	RAM® Pin-Lock™ Security Nut Included
RAM-S-D-111U-C	Drill-Down	Short	RAM® Pin-Lock™ Security Nut Included

*RAM® Hi-Torq™ Wrench Required for 16" Fishfinders

"109" SERIES SWING ARM MOUNTS WITH 6.25" X 2" PLATE

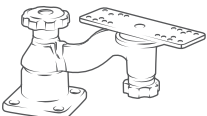

PART NUMBER	BASE TYPE	SWING ARM TYPE	NOTES
BEST SELLER RAM-109H	Horizontal	Single	-
RAM-109H-1	Horizontal	Double	-
RAM-109HSB*	Horizontal	Single	C Size 1.5" Ball & Socket Adapter
RAM-109H-2*	Horizontal	Single w/ Double Socket Arm	C Size 1.5" Ball & Socket Adapter
RAM-109V	Vertical	Single	-
RAM-109V-1	Vertical	Double	-
RAM-109VSB*	Vertical	Medium	C Size 1.5" Ball & Socket Adapter
RAM-109V-2*	Vertical	Single w/ Double Socket Arm	C Size 1.5" Ball & Socket Adapter

*Mounts with C Size 1.5" Ball are only recommended for up to 7" Fishfinders

CUSTOM MOUNTS

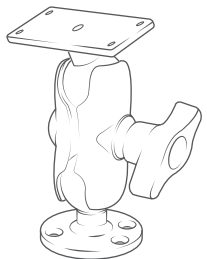

PART NUMBER	BRAND	MODEL	BALL SIZE	MOUNT TYPE	ARM LENGTH	MATERIAL
RAM-B-101-G4	Garmin	Echomap Plus 42-45cv, echo-MAP CHIRP 43cv, STRIKER 4/ Plus 4/cv	B Size 1"	Drill-Down	Medium	Marine-Grade Aluminum
BEST SELLER RAM-101-G4	Garmin	Echomap Plus 42-45cv, echo-MAP CHIRP 43cv, STRIKER 4/ Plus 4/cv	C Size 1.5"	Drill-Down	Medium	Marine-Grade Aluminum
RAP-B-101U-G4	Garmin	Echomap Plus 42-45cv, echo-MAP CHIRP 43cv, STRIKER 4/ Plus 4/cv	B Size 1"	Drill-Down	Medium	High Strength Composite
RAP-101U-G4	Garmin	Echomap Plus 42-45cv, echo-MAP CHIRP 43cv, STRIKER 4/ Plus 4/cv	C Size 1.5"	Drill-Down	Medium	High Strength Composite
RAM-B-107-1	Humminbird	PiranhaMax 4	B Size 1"	Drill-Down	Medium	Marine-Grade Aluminum
RAP-B-107-1B-354-TRA1	Humminbird	PiranhaMax 4	B Size 1"	Track	Medium	High Strength Composite
RAP-B-107-1U	Humminbird	PiranhaMax 4	B Size 1"	Drill-Down	Medium	High Strength Composite
RAM-B-107-1U-238	Humminbird	PiranhaMax 4	B Size 1"	Drill-Down	Medium	Marine-Grade Aluminum
RAM-202-153-B-202	Humminbird	Helix 5	C Size 1.5"	Drill-Down	Short	Marine-Grade Aluminum
RAM-202-153-202U	Humminbird	Helix 5	C Size 1.5"	Drill-Down	Medium	Marine-Grade Aluminum
RAP-B-202-153-354-TRA1	Humminbird	Helix 5	B Size 1"	Track	Medium	High Strength Composite
RAP-202-153-202	Humminbird	Helix 5	C Size 1.5"	Drill-Down	Medium	High Strength Composite
RAM-202-24-B-202U	Humminbird	Helix 7	C Size 1.5"	Drill-Down	Short	Marine-Grade Aluminum
RAM-202-24-202U	Humminbird	Helix 7	C Size 1.5"	Drill-Down	Medium	Marine-Grade Aluminum
RAM-202-24-354-TRA1U	Humminbird	Helix 7	C Size 1.5"	Track	Medium	Marine-Grade Aluminum
BEST SELLER RAM-D-202-25-C-202U	Humminbird	Helix 8, 9, 10, Solix 10, 12, 15	D Size 2.25"	Drill-Down	Short	Marine-Grade Aluminum
RAM-101-LO12	Lowrance	HOOK Reveal 5	C Size 1.5"	Drill-Down	Medium	Marine-Grade Aluminum
RAM-B-101-LO12	Lowrance	HOOK Reveal 5	B Size 1"	Drill-Down	Medium	Marine-Grade Aluminum
BEST SELLER RAM-B-LO12-354-TRA1	Lowrance	HOOK Reveal 5	B Size 1"	Track	Medium	Marine-Grade Aluminum
RAP-101-LO12	Lowrance	HOOK Reveal 5	C Size 1.5"	Drill-Down	Medium	High Strength Composite
RAP-B-101-LO12	Lowrance	HOOK Reveal 5	B Size 1"	Drill-Down	Medium	High Strength Composite
RAM-109H-2B-B-LO11	Lowrance	Elite-7 Ti ²	C Size 1.5"	Drill-Down, Horizontal Swing Arm	Medium + Single Swing Arm	Marine-Grade Aluminum
RAP-101U-LO11	Lowrance	Elite-7 Ti ²	C Size 1.5"	Drill-Down	Medium	High Strength Composite
RAM-B-202-379-M616	Raymarine	Dragonfly 5 Pro, 7 Pro	B Size 1"	Drill-Down	Medium	Marine-Grade Aluminum
RAM-B-400-379-M616	Raymarine	Dragonfly 5 Pro, 7 Pro	B Size 1"	Rail Clamp	Medium	Marine-Grade Aluminum

FISHING ROD HOLDERS

RAM ROD®

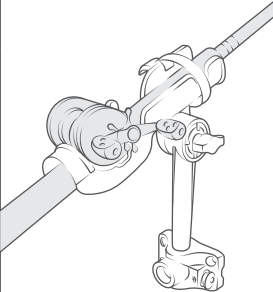
	PART NUMBER	MOUNT TYPE	BASE TYPE	HOLDER	NOTES
	RAM-114-B	Post & Spline	Bulkhead Base	RAM-114-NB	-
	BEST SELLER RAM-114-BMP	Post & Spline	Combo Bulkhead Base	RAM-114-NB	-
	RAM-114-D	Post & Spline	Deck Drill-Down Base	RAM-114-NB	-
	RAP-114-421	Post & Spline	Dual T-Bolt Track Base	RAM-114-NB	-
	RAP-114-PA-421	Post & Spline	Dual T-Bolt Track Base	-	Dual Ratchet Adjustment
	RAM-114-F	Post & Spline	Flush Base	RAM-114-NB	-
	RAM-114-RBSW	Ball & Socket w/ Ratchet	Drill-Down Ball Base	RAM-114-RBNBU	Stainless Steel Base for Saltwater
	RAM-114-RB	Ball & Socket w/ Ratchet	Drill-Down Ball Base	RAM-114-RBNBU	Marine-Grade Aluminum Base for Freshwater
	RAP-340	Ball & Socket	Drill-Down Ball Base	RAP-340NB	Low Profile
	RAP-341	Ball & Socket	Drill-Down Ball Base	RAP-341NB	Low Profile, Fly Rod Holder
	RAM-114-RB-TRA1	Ball & Socket w/ Ratchet	RAM® Track Ball™	RAM-114-RBNBU	
	RAP-340-TRA1	Ball & Socket	RAM® Track Ball™	RAP-340NB	Low Profile
	RAP-341-TRA1	Ball & Socket	RAM® Track Ball™	RAP-341NB	Low Profile, Fly Rod Holder
	RAM-117SWJ	Double Ball & Socket	Drill-Down Ball Base	RAM-117B	Stainless Steel Base for Saltwater
	RAM-117	Double Ball & Socket	Drill-Down Ball Base	RAM-117B	Marine-Grade Aluminum Base for Freshwater
	RAP-114-PA-411	Ratchet	RAM® Track-Node™ Base	-	-

RAM ROD® HD

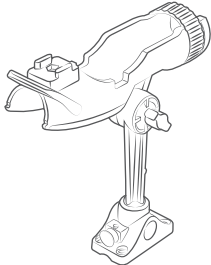
	PART NUMBER	BASE TYPE	HOLDER
	BEST SELLER RAP-433-BMP	Combo Bulkhead Base	RAP-433-NB
	RAP-433-421	Dual T-Bolt Track Base	RAP-433-NB
	RAP-433-PA-411	RAM® Track-Node™ Base	-

RAM ROD® JR

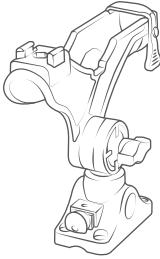
	PART NUMBER	BASE TYPE	HOLDER
	RAP-434-BMP	Combo Bulkhead Base	RAP-434-NB
	BEST SELLER RAP-434-421	Dual T-Bolt Track Base	RAP-434-NB
	RAP-434-PA-411	RAM® Track-Node™ Base	-
	RAP-434-RB-TRA1	RAM® Track Ball™	RAP-434-RBNB

RAM® TUBE™

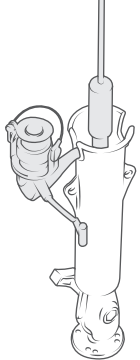
	PART NUMBER	MOUNT TYPE	BASE TYPE	HOLDER	NOTES
	RAM-119	Ball & Socket	Drill-Down Ball Base	RAM-119B	
	BEST SELLER RAM-301-BMP	Post & Spline	Combo Bulkhead Base	RAM-301-NB	
	RAM-301-B	Post & Spline	Bulkhead Base	RAM-301-NB	
	RAM-301-D	Post & Spline	Deck Drill-Down Base	RAM-301-NB	
	RAM-301-F	Post & Spline	Flush Base	RAM-301-NB	
	RAM-301-RBSW	Ball & Socket w Ratchet	Drill-Down Ball Base	RAM-301-RBNBU	Stainless Steel Base for Saltwater
	RAM-301-RB	Ball & Socket w Ratchet	Drill-Down Ball Base	RAM-301-RBNBU	Marine-Grade Aluminum Base for Freshwater
	RAP-119-TRA1	Ball & Socket	RAM® Track Ball™	RAP-119NB	
	RAP-119SW	Ball & Socket	Drill-Down Ball Base	RAP-119NB	Stainless Steel Base for Saltwater
	RAP-119	Ball & Socket	Drill-Down Ball Base	RAP-119NB	Marine-Grade Aluminum Base for Freshwater

FISHING ROD HOLDERS

RAM® TOUGH-TUBE™

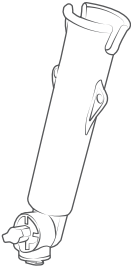
	PART NUMBER	BASE TYPE	HOLDER
	BEST SELLER RAP-394-SSBMP	Combo Bulkhead Base	RAP-394-SST
RAP-394-SSF	Flush Base	RAP-394-SST	
RAP-394-SSFMT	Flush Base - Round	RAP-394-SST	
RAP-385-12-394	Flush Tube Wedge Adapter	-	
RAP-394-418	Track Base	-	

RAM® TUBE JR.™

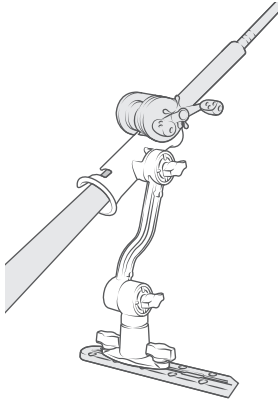
	PART NUMBER	MOUNT TYPE	BASE TYPE	POST LENGTH	HOLDER
	RAP-390-BMP	Post & Spline	Combo Bulkhead Base	6"	RAP-390U
RAP-390-SBMP	Post & Spline	Combo Bulkhead Base	3.75"	RAP-390-STU	
RAP-390-BU	Post & Spline	Bulkhead Base	6"	RAP-390U	
RAP-390-SBU	Post & Spline	Bulkhead Base	3.75"	RAP-390-STU	
RAP-390-F	Post & Spline	Flush Base	6"	RAP-390U	
RAP-390-SF	Post & Spline	Flush Base	3.75"	RAP-390-STU	
RAP-390-FMT	Post & Spline	Flush Base - Round	6"	RAP-390U	
RAP-390-SFMTU	Post & Spline	Flush Base - Round	3.75"	RAP-390-STU	
RAP-390-AAPUTU	Post & Spline	RAM® Universal Adapt-A-Post™	6"	RAP-390U	
RAP-390-SAAPUTU	Post & Spline	RAM® Universal Adapt-A-Post™	3.75"	RAP-390-STU	
RAP-390-421	Post & Spline	Dual T-Bolt Track Base	6"	RAP-390U	
RAP-390-PA-421	Post & Spline w/ Extra Ratchet	Dual T-Bolt Track Base	-	RAP-390-NPU	
RAP-390-PA-411	Ratchet	RAM® Track-Node™ Base	-	RAP-390-NPU	
RAP-390-PA-418	Ratchet	Track Base	-	RAP-390-NPU	
RAP-390-RB	Ball & Socket w/ Ratchet	Drill-Down Ball Base	-	RAP-390-RB-NBU	
BEST SELLER RAP-390-RB-TRA1	Ball & Socket w/ Ratchet	RAM® Track Ball™	-	RAP-390-RB-NBU	

RAM® POST & SPLINE COMPONENTS

BASES

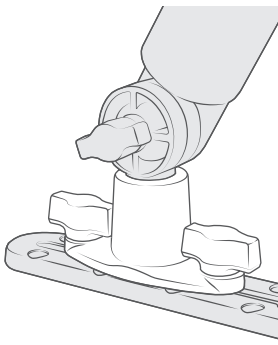
	PART NUMBER	BASE TYPE	HOLDER
	RAM-114BM	Bulkhead Drill-Down Base	-
RAP-AAPUBU	Bulkhead Drill-Down Base	RAM® Universal Adapt-A-Post™	
RAM-114BMP	Combo Bulkhead Base	-	
RAM-114FM	Flush Drill-Down Base	-	
RAM-114FMT	Flush Drill-Down Base - Round	-	
RAP-AAPUDTU	2-Hole Drill-Down Base	RAM® Universal Adapt-A-Post™	
RAM-114DTM5	4-Hole Drill-Down Base	-	
RAP-AAPUDU	4-Hole Drill-Down Base	RAM® Universal Adapt-A-Post™	
RAP-AAPUH-1U	Hobie H-Rail Adapter	RAM® Universal Adapt-A-Post™	
RAP-411-AAPU	RAM® Track-Node™ Base	RAM® Adapt-A-Post™	
RAP-AAPUTU	Track Base	RAM® Universal Adapt-A-Post™	
BEST SELLER RAP-421	Track Base - Dual T-Bolt	-	
RAP-AAPUDT-1U	Track Base - Dual T-Bolt	-	
RAP-AAPRU	Track Base - Vertical	RAM® Adapt-A-Post™	

ROD HOLDERS WITH POST

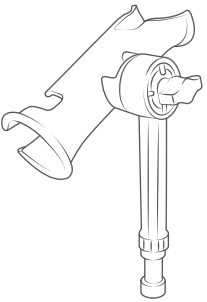
	PART NUMBER	SERIES	POST LENGTH
	BEST SELLER RAM-114-NBU	RAM ROD®	6"
RAP-394-SSTU	RAM® Tough-Tube™	2"	
RAP-390U	RAM® Tube Jr.™	6"	
RAP-390-STU	RAM® Tube Jr.™	3.75"	
RAP-433-NB	RAM ROD® HD	6"	
RAM-301-NB	RAM® Tube™	6"	
RAP-434-NB	RAM ROD® JR	2"	

RAM® POST & SPLINE COMPONENTS

POST ADAPTERS & EXTENSIONS

	POST ADAPTERS & EXTENSIONS		
	PART NUMBER	PART TYPE	LENGTH
	RAP-114-EX6	Extension Arm - PVC Pipe	6"
	RAP-114-EX8	Extension Arm - PVC Pipe	8"
	RAP-114-EX12	Extension Arm - PVC Pipe	12"
	BEST SELLER RAP-114-APB2U	Extension Arm - Ratchet	13.5"
	RAP-114-APB3U	Extension Arm - Ratchet	16"
	RAP-B-354-419U	B Size 1" Ball Adapter	-
	RAP-B-354-75U	B Size 1" Ball Wedge Adapter	-
	RAP-354-419U	C Size 1.5" Ball Adapter	-
	RAP-354-75U	C Size 1.5" Ball Wedge Adapter	-
	RAP-114-PSPU	PVC Socket Adapter	-
	RAP-114FFRU	RAM® Flex-Rod™ Adapter	-
	RAP-114-5PU	5-Spot Post Adapter	-

TRANSDUCER MOUNTS

POST ADAPTERS & EXTENSIONS

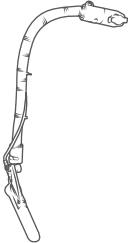
	POST ADAPTERS & EXTENSIONS		
	PART NUMBER	TRANSDUCER CONNECTION	MOUNT TYPE
	RAM-B-316-18-TRA1-NB	1/4"-20 Screw	B Size 1" Socket Arm
	RAM-B-316-18-TRA1	1/4"-20 Screw	2-Hole Drill-Down Base
	RAM-B-316-18-TRA1-202-225	1/4"-20 Screw	4-Hole Drill-Down Base
	RAM-B-316-18-TRA1-354-75	1/4"-20 Screw	B Size 1" Ball Wedge Adapter
	BEST SELLER RAM-B-316-18-TRA1-TRA1	1/4"-20 Screw	RAM® Track Ball™ Base
	RAM-B-316-18-TRA2-NB	HydroWave™	B Size 1" Socket Arm
	RAM-B-316-18-TRA2	HydroWave™	2-Hole Drill-Down Base
	RAM-B-316-18-TRA3-NB	Lowrance StructureScan	B Size 1" Socket Arm
	RAM-B-316-18-TRA3	Lowrance StructureScan	2-Hole Drill-Down Base
	RAM-316-18-TRA4-NB	Lowrance TotalScan	C Size 1.5" Socket Arm

PHONE COMPATIBILITY

PHONE COMPATIBILITY - HOLDERS

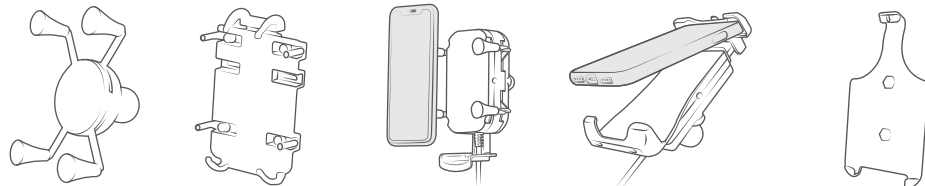

MAKE	MODEL	RAM® X-GRIP®	RAM® QUICK-GRIP™	RAM® TOUGH-CHARGE™ WIRELESS CHARGER	RAM® QUICK-GRIP™ WIRELESS CHARGER	CUSTOM FORM-FIT	
Apple	iPhone 11	"UN7" Series	RAM-HOL-PD4-238A	RAM-HOL-UN12WB	RAM-HOL-UN14WB	RAM-HOL-AP28U	
	iPhone 11 Pro	"UN7" Series	RAM-HOL-PD3-238A	RAM-HOL-UN12WB	RAM-HOL-UN14WB	RAM-HOL-AP29U	
	iPhone 11 Pro Max	"UN10" Series	RAM-HOL-PD4-238A	RAM-HOL-UN12WB	RAM-HOL-UN14WB	RAM-HOL-AP30U	
	iPhone SE	"UN7" Series	RAM-HOL-PD3-238A	RAM-HOL-UN12WB	RAM-HOL-UN14WB	-	
	iPhone Xr	"UN7" Series	RAM-HOL-PD4-238A	RAM-HOL-UN12WB	RAM-HOL-UN14WB	RAM-HOL-AP26U	
	iPhone Xs	"UN7" Series	RAM-HOL-PD3-238A	RAM-HOL-UN12WB	RAM-HOL-UN14WB	RAM-HOL-AP25U	
Google	iPhone Xs Max	"UN10" Series	RAM-HOL-PD4-238A	RAM-HOL-UN12WB	RAM-HOL-UN14WB	RAM-HOL-AP19U	
	Pixel 4	"UN7" Series	RAM-HOL-PD4-238A	RAM-HOL-UN12WB	RAM-HOL-UN14WB	-	
LG	Pixel 4 XL	"UN7" Series	RAM-HOL-PD4-238A	RAM-HOL-UN12WB	RAM-HOL-UN14WB	-	
	G7 ThinQ	"UN7" Series	RAM-HOL-PD4-238A	RAM-HOL-UN12WB	RAM-HOL-UN14WB	-	
	G8 ThinQ	"UN7" Series	RAM-HOL-PD4-238A	RAM-HOL-UN12WB	RAM-HOL-UN14WB	-	
Samsung	G8S ThinQ	"UN10" Series	RAM-HOL-PD4-238A	RAM-HOL-UN12WB	RAM-HOL-UN14WB	-	
	Galaxy Note 10	"UN7" Series	RAM-HOL-PD4-238A	RAM-HOL-UN12WB	RAM-HOL-UN14WB	-	
	Galaxy Note 10 Plus	"UN10" Series	RAM-HOL-PD4-238A	RAM-HOL-UN12WB	RAM-HOL-UN14WB	-	
	Galaxy S10	"UN7" Series	RAM-HOL-PD4-238A	RAM-HOL-UN12WB	RAM-HOL-UN14WB	-	
	Galaxy S10 5G	"UN10" Series	RAM-HOL-PD4-238A	RAM-HOL-UN12WB	RAM-HOL-UN14WB	-	
	Galaxy S10+	"UN7" Series	RAM-HOL-PD4-238A	RAM-HOL-UN12WB	RAM-HOL-UN14WB	-	
	Galaxy S10e	"UN7" Series	RAM-HOL-PD3-238A	RAM-HOL-UN12WB	-	-	
	Galaxy S20	"UN7" Series	RAM-HOL-PD4-238A	RAM-HOL-UN12WB	RAM-HOL-UN14WB	-	
	Galaxy S20 Ultra 5G	"UN7" Series	RAM-HOL-PD4-238A	RAM-HOL-UN12WB	RAM-HOL-UN14WB	-	
	Galaxy S20+	"UN7" Series	RAM-HOL-PD4-238A	RAM-HOL-UN12WB	RAM-HOL-UN14WB	-	
	Galaxy XCover FieldPro	"UN10" Series	RAM-HOL-PD4-238A	-	-	RAM-HOL-SAM72PU	
	Galaxy Xcover Pro		"UN10" Series	RAM-HOL-PD4-238A	-	-	RAM-HOL-SAM59U
							RAM-HOL-SAM9PU
						RAM-HOL-SAM9P-OT2U	

RAM® X-GRIP® PHONE MOUNTS

INTRO

BOATING MOUNTS

KAYAK MOUNTS

DEVICE MOUNTS

ACCESSORIES & MORE

PRODUCT CHARTS

"UN7" SERIES FITS PHONES UP TO 3" WIDE

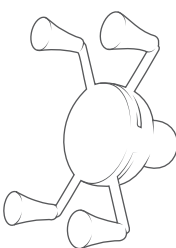
	PART NUMBER	MOUNT FUNCTION	ARM LENGTH	DESCRIPTION
	RAM-HOL-UN7BU	-	-	Holder Only - B Size 1" Ball
	RAP-B-378-A-UN7U	Adhesive	Short	Flex Adhesive Mount
	RAP-B-378-UN7	Adhesive	Medium	Flex Adhesive Mount
	RAP-SB-180-UN7	Adhesive	-	RAM® Lil-Buddy™ Low Profile Mount
	RAP-B-299-4-UN7U	Cup Holder	Medium	RAM® Stubby™ Cup Holder Mount
	RAM-B-138-UN7	Drill-Down - 4-Hole	Medium	Marine-Grade Aluminum
	RAM-B-102-UN7	Drill-Down - 2-Hole	Medium	Marine-Grade Aluminum
	RAP-B-138-UN7	Drill Down - 4-Hole	Medium	High Strength Composite
	RAP-B-GOP2-UN7U	GoPro Receiver	Medium	GoPro Receiver Mount Compatible
	RAM-B-149Z-A-UN7U	Rail & Handlebar	Short	U-Bolt Mount
	RAM-B-149Z-UN7	Rail & Handlebar	Medium	U-Bolt Mount
	RAM-B-400-A-HOL-UN7BU	Rail & Handlebar	Short	RAM® Tough-Claw™ Mount
	RAM-B-400-C-UN7U	Rail & Handlebar	Long	RAM® Tough-Claw™ Mount
	RAM-B-400-UN7	Rail & Handlebar	Medium	RAM® Tough-Claw™ Mount
	RAM-B-231-2-UN7	Rail & Roll Bar	Medium	Strap Hose Clamp Mount
RAM-B-166-A-UN7U	Suction Cup	Short	RAM® Twist-Lock™ Suction Cup	
BEST SELLER RAM-B-166-UN7	Suction Cup	Medium	RAM® Twist-Lock™ Suction Cup	
RAP-HOL-UN7B-354-TRA1	Track	Medium	RAM® Track Ball™ Mount	
RAM-B-177-UN7U	Windshield Clamp	Short	Clamps up to .625" Thick	

"UN10" SERIES FITS PHONES UP TO 4.5" WIDE

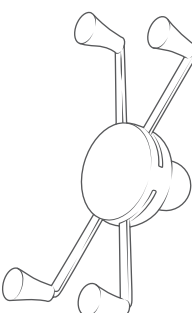
	PART NUMBER	MOUNT FUNCTION	ARM LENGTH	DESCRIPTION
	RAM-HOL-UN10BU	-	-	Holder Only - B Size 1" Ball
	RAP-B-378-UN10U	Adhesive	Medium	Flex Adhesive Mount
	RAP-B-299-4-UN10U	Cup Holder	Medium	RAM® Stubby™ Cup Holder Mount
	RAM-B-138-UN10	Drill Down - 4-Hole	Medium	Marine-Grade Aluminum
	RAM-B-102-UN10U	Drill-Down - 2-Hole	Medium	Marine-Grade Aluminum
	RAM-B-149Z-A-UN10U	Rail & Handlebar	Short	U-Bolt Mount
	RAM-B-149Z-UN10	Rail & Handlebar	Medium	U-Bolt Mount
	RAM-B-400-C-UN10U	Rail & Handlebar	Long	RAM® Tough-Claw™ Mount
	RAM-B-400-HOL-UN10BU	Rail & Handlebar	Medium	RAM® Tough-Claw™ Mount
	RAM-B-231-2-UN10	Rail & Roll Bar	Medium	Strap Hose Clamp Mount
	RAM-B-166-C-UN10U	Suction Cup	Long	RAM® Twist-Lock™ Suction Cup
	BEST SELLER RAM-B-166-UN10	Suction Cup	Medium	RAM® Twist-Lock™ Suction Cup

RAM® QUICK-GRIP™ MOUNTS

"PD3" SERIES HEIGHT RANGE: 4.75" - 5.75", WIDTH RANGE: 2.19" X 3.25", AX DEPTH: .72"

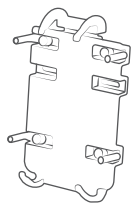
	PART NUMBER	MOUNT FUNCTION	ARM LENGTH	DESCRIPTION
	RAM-HOL-PD3-238A	-	-	Holder Only - B Size 1" Ball
	RAM-B-138-PD3	Drill Down - 4-Hole	Medium	Marine-Grade Aluminum
	RAM-B-102-PD3U	Drill-Down - 2-Hole	Medium	Marine-Grade Aluminum
	RAM-B-149Z-A-PD3	Rail & Handlebar	Short	U-Bolt Mount
	RAM-B-149Z-PD3	Rail & Handlebar	Medium	U-Bolt Mount
	BEST SELLER RAM-B-166-PD3	Suction Cup	Medium	RAM® Twist-Lock™ Suction Cup

"PD4" SERIES HEIGHT RANGE: 5.75" - 8.25", WIDTH RANGE: 2.625" X 3.625", MAX DEPTH: .72"

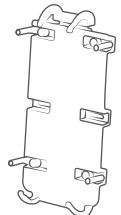
	PART NUMBER	MOUNT FUNCTION	ARM LENGTH	DESCRIPTION
	RAM-HOL-PD4-238AU	-	-	Holder Only - B Size 1" Ball
	BEST SELLER RAM-B-138-PD4U	Drill Down - 4-Hole	Medium	Marine-Grade Aluminum
	RAM-B-149Z-A-PD4	Rail & Handlebar	Short	U-Bolt Mount
	RAM-B-149Z-PD4U	Rail & Handlebar	Medium	U-Bolt Mount

WIRELESS CHARGER MOUNTS

RAM® TOUGH-CHARGE™ WITH X-GRIP® TECH WATERPROOF WIRELESS CHARGER

WIDTH RANGE: 2.625" X 3.625"

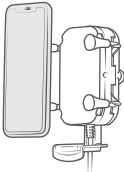
	PART NUMBER	MOUNT FUNCTION	ARM LENGTH	DESCRIPTION
	RAM-HOL-UN12WB	-	-	Holder Only - B Size 1" Ball
	RAM-HOL-UN12WB-V7M	-	-	Holder Only - B Size 1" Ball Hardwire Charger Included
	RAM-B-166-UN12W	Suction Cup	Medium	RAM® Twist-Lock™ Suction Cup
	RAM-B-149Z-A-UN12W-V7M	Rail & Handlebar	Short	U-Bolt Mount Hardwire Charger Included
BEST SELLER RAM-B-400-A-UN12W-V7M	Rail & Handlebar	Short	RAM® Tough-Claw™ Mount Hardwire Charger Included	

RAM® QUICK-GRIP™ WATERPROOF WIRELESS CHARGER

HEIGHT RANGE: 5.625" - 6.625", MAX WIDTH: 3.125", MAX DEPTH: .7"

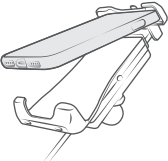
	PART NUMBER	MOUNT FUNCTION	ARM LENGTH	DESCRIPTION
	RAM-HOL-UN14WB	-	-	Holder Only - B Size 1" Ball
	RAM-HOL-UN14WB-V7M	-	-	Holder Only - B Size 1" Ball Hardwire Charger Included
	RAM-B-166-UN14W	Suction Cup	Medium	RAM® Twist-Lock™ Suction Cup
	RAM-B-149Z-A-UN14W-V7M	Rail & Handlebar	Short	U-Bolt Mount Hardwire Charger Included
BEST SELLER RAM-B-400-A-UN14W-V7M	Rail & Handlebar	Short	RAM® Tough-Claw™ Mount Hardwire Charger Included	

TABLET HOLDERS

PAIR WITH ANY TABLET MOUNT

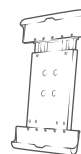
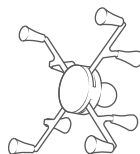

MAKE	MODEL	RAM® X-GRIP®	RAM® TAB-TITE™	FORM-FIT
Apple	iPad (6th Generation) without Case	RAM-HOL-UN9U	RAM-HOL-TAB28U	RAM-HOL-AP17U
	iPad (6th Generation) with Case	RAM-HOL-UN9U	RAM-HOL-TAB20U	-
	iPad (7th Generation) without Case	RAM-HOL-UN9U	RAM-HOL-TAB26U	RAM-HOL-AP31U
	iPad (7th Generation) with Case	RAM-HOL-UN9U	RAM-HOL-TAB20U	-
	iPad Air 3 without Case	RAM-HOL-UN9U	RAM-HOL-TAB26U	RAM-HOL-AP22U
	iPad Air 3 with Case	RAM-HOL-UN9U	RAM-HOL-TAB20U	-
	iPad mini 4 & 5 without Case	RAM-HOL-UN8BCU	RAM-HOL-TAB30U	RAM-HOL-AP20U
	iPad mini 4 & 5 with Case	RAM-HOL-UN8BCU	RAM-HOL-TAB29U	-
	iPad Pro 10.5 (2nd Generation) without Case	RAM-HOL-UN9U	RAM-HOL-TAB26U	RAM-HOL-AP22U
	iPad Pro 10.5 (2nd Generation) with Case	RAM-HOL-UN9U	RAM-HOL-TAB20U	-
	iPad Pro 11" without Case	RAM-HOL-UN9U	RAM-HOL-TAB3U	RAM-HOL-AP23U
	iPad Pro 11" with Case	RAM-HOL-UN9U	RAM-HOL-TAB17U	-
	iPad Pro 11" (2020) without Case	RAM-HOL-UN9U	RAM-HOL-TAB3U	RAM-HOL-AP23U
	iPad Pro 11" (2020) with Case	RAM-HOL-UN9U	RAM-HOL-TAB17U	-
Samsung	iPad Pro 12.9 (3rd Gen) without Case	RAM-HOL-UN11U	-	-
	iPad Pro 12.9 (4th Gen) without Case	RAM-HOL-UN11U	-	-
	Galaxy Tab A 10.1 (2019) without Case	-	RAM-HOL-TAB29U	-
	Galaxy Tab A 10.1 (2019) with Case	-	RAM-HOL-TAB25U	-
	Galaxy Tab A 10.5 without Case	RAM-HOL-UN9U	RAM-HOL-TAB28U	-
	Galaxy Tab A 10.5 with Case	RAM-HOL-UN9U	RAM-HOL-TAB20U	-
	Galaxy Tab A 8.0 (2018) without Case	RAM-HOL-UN8BCU	RAM-HOL-TAB24U	-
	Galaxy Tab A 8.0 (2018) with Case	RAM-HOL-UN8BCU	RAM-HOL-TAB12U	-
	Galaxy Tab A 8.0 (2019) without Case	RAM-HOL-UN8BCU	RAM-HOL-TAB24U	-
	Galaxy Tab A 8.0 (2019) with Case	RAM-HOL-UN8BCU	RAM-HOL-TAB12U	-
	Galaxy Tab A 8.4 without Case	RAM-HOL-UN8BCU	RAM-HOL-TAB30U	-
	Galaxy Tab A 8.4 with Case	RAM-HOL-UN8BCU	RAM-HOL-TAB12U	-
	Galaxy Tab A 9.7 without Case	RAM-HOL-UN9U	RAM-HOL-TAB28U	-
	Galaxy Tab A 9.7 with Case	RAM-HOL-UN9U	RAM-HOL-TAB20U	-
	Galaxy Tab Active2 without Case	RAM-HOL-UN8BCU	-	-
	Galaxy Tab Active2 with Case	RAM-HOL-UN8BCU	-	RAM-HOL-SAM7PAU
	Galaxy Tab Active Pro without Case	RAM-HOL-UN9U	RAM-HOL-TAB6U	-
	Galaxy Tab Active Pro with Case	RAM-HOL-UN9U	RAM-HOL-TAB20U	-
	Galaxy Tab E 7.0 without Case	RAM-HOL-UN8BCU	RAM-HOL-TAB18U	-
	Galaxy Tab E 7.0 with Case	RAM-HOL-UN8BCU	RAM-HOL-TAB4U	-
	Galaxy Tab E 8.0 without Case	RAM-HOL-UN8BCU	RAM-HOL-TAB24U	-
	Galaxy Tab E 8.0 with Case	RAM-HOL-UN8BCU	RAM-HOL-TAB12U	-
	Galaxy Tab S5e without Case	RAM-HOL-UN9U	-	-
	Galaxy Tab S5e with Case	RAM-HOL-UN9U	-	-
	Galaxy Tab S6 without Case	RAM-HOL-UN9U	RAM-HOL-TAB28U	-
	Galaxy Tab S6 with Case	RAM-HOL-UN9U	RAM-HOL-TAB20U	-

TABLET MOUNTS

PAIR WITH ANY TABLET HOLDER HEAVY-DUTY C SIZE 1.5" BALL & SOCKET MOUNTING SYSTEMS

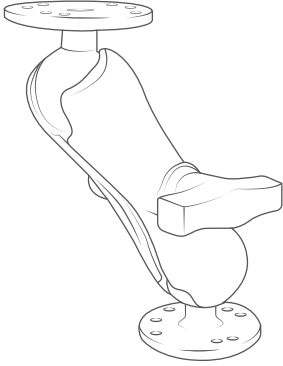
	PART NUMBER	MOUNT FUNCTION	DESCRIPTION	ARM LENGTH	CLAMP RANGE
	RAM-101	Drill-Down	Double Ball Mount	Medium	-
	RAM-101U-B	Drill-Down	Double Ball Mount	Short	-
	BEST SELLER RAM-101U-D	Drill-Down	Double Ball Mount	Long	-
	RAM-109H-3U	Drill-Down	Horizontal Swing Arm Mount	-	-
	RAM-109V-3U	Drill-Down	Vertical Swing Arm Mount	-	-
	RAM-101U-235	Rail & Handlebar	Double U-Bolt Mount	Medium	1" - 1.25" Diameter
	RAM-101U-B-235	Rail & Handlebar	Double U-Bolt Mount	Short	1" - 1.25" Diameter
	RAM-101U-235-1	Rail & Handlebar	Double U-Bolt Mount	Medium	1.25" - 1.5" Diameter
	RAM-202-400	Rail & Handlebar	RAM® Tough-Claw™ - Small	Medium	.625" - 1.5" Diameter
RAM-202-B-400	Rail & Handlebar	RAM® Tough-Claw™ - Small	Short	.625" - 1.5" Diameter	
RAP-404-202U	Rail & Handlebar	RAM® Tough-Claw™ - Medium	Medium	1" - 1.875" Diameter	
RAP-401-202U	Rail & Handlebar	RAM® Tough-Claw™ - Large	Medium	1" - 2.25" Diameter	

CAMERA MOUNTS

CAMERA MOUNTS - DOUBLE BALL MOUNTS

	PART NUMBER	MOUNT FUNCTION	ARM LENGTH	DESCRIPTION	CLAMP RANGE	
	RAP-B-202-GOP1	-	-	-	Holder Only - B Size 1" Ball	-
	RAP-B-378-202U-GOP1	Adhesive	Medium	Flex Adhesive Mount	-	
	RAM-B-102-GOP1	Drill-Down - 2-Hole	Medium	Marine-Grade Aluminum	-	
	RAM-B-138-A-GOP1	Drill Down - 4-Hole	Short	Marine-Grade Aluminum	-	
	RAM-B-138-GOP1	Drill Down - 4-Hole	Medium	Marine-Grade Aluminum	-	
	RAM-B-138-C-GOP1	Drill Down - 4-Hole	Long	Marine-Grade Aluminum	-	
	RAP-B-138-GOP1	Drill Down - 4-Hole	Medium	High Strength Composite	-	
	RAP-B-GOP2-A-GOP1	GoPro Receiver	Short	GoPro Receiver Mount Compatible	-	
	RAP-B-218-1-GOP1U	Pole Adapter	Medium	Connects to 0.715" OD Threaded Poles	-	
RAM-B-149Z-A-GOP1	Rail & Handlebar	Short	U-Bolt Mount	.5" - 1.25" Diameter		
RAM-B-149Z-GOP1	Rail & Handlebar	Medium	U-Bolt Mount	.5" - 1.25" Diameter		
RAM-B-400-A-GOP1U	Rail & Handlebar	Short	RAM® Tough-Claw™ Mount	.625" - 1.5" Diameter		
BEST SELLER RAM-B-400-GOP1	Rail & Handlebar	Medium	RAM® Tough-Claw™ Mount	.625" - 1.5" Diameter		
RAP-B-404-GOP1U	Rail & Handlebar	Medium	RAM® Tough-Claw™ Mount	1" - 1.875" Diameter		
RAM-B-108-GOP1	Rail & Handlebar	Medium	Strap Hose Clamp Mount	1" - 2.1" Diameter		
RAM-B-149Z-2-GOP1	Rail & Roll Bar	Medium	Strap Hose Clamp Mount	.5" - 3.15" Diameter		
RAM-B-166-A-GOP1	Suction Cup	Short	RAM® Twist-Lock™ Suction Cup	-		
RAM-B-166-GOP1	Suction Cup	Medium	RAM® Twist-Lock™ Suction Cup	-		
RAP-B-202-GOP1-354-TRA1	Track	Medium	RAM® Track Ball™ Mount	-		

CAMERA MOUNTS - RAM® TOUGH-POLE™

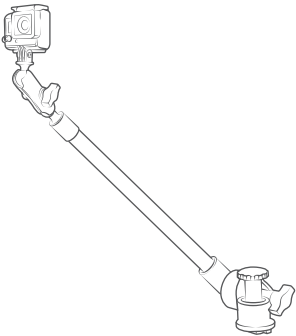
	PART NUMBER	MOUNT TYPE	BASE TYPE	OVERALL HEIGHT
	RAP-354-TRA1-12-A-GOP1	Ball & Socket	RAM® Track Ball™	22"
	RAP-425-18-A-GOP1	Fixed PVC Pipe Mount	Track Base	23"
	RAP-425-4-18-A-GOP1	Fixed PVC Pipe Mount	Track Base	33"
	RAP-425-18-18-A-GOP1	Fixed PVC Pipe Mount	Track Base	47"
	RAP-425-4-A-GOP1	Fixed PVC Pipe Mount	Track Base	9"
	RAP-114BD-4-12-A-GOP1	Post & Spline	Combo Bulkhead Base	29"
	RAP-114BD-4-12-4-A-GOP1	Post & Spline	Combo Bulkhead Base	38"
	RAP-411-18-A-GOP1	Post & Spline	Dual T-Bolt Track Base	24"
	RAP-411-18-18-A-GOP1	Post & Spline	Dual T-Bolt Track Base	48"
RAP-411-18-A-GOP1-1	RAM® Track-Node™	Track Base	22"	
BEST SELLER RAP-411-18-18-A-GOP1-1	RAM® Track-Node™	Track Base	46"	
RAP-385-12-18-A-GOP1	Ratchet PVC Pipe	Flush Tube Wedge Adapter	24"	
RAP-385-12-18-18-A-GOP1	Ratchet PVC Pipe	Flush Tube Wedge Adapter	44"	

HANDHELD GPS & RADIO MOUNTS SELECT ANY HOLDER + ARM + BASE

HOLDERS

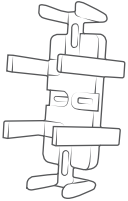
	MAKE	PART NUMBER	MODEL
	Garmin		RAM-HOL-GA41
		RAM-HOL-GA41	GPSMAP 64sc
BEST SELLER		RAM-HOL-GA76U	GPSMAP 66i
		RAM-HOL-GA40	GPSMAP 78sc
		RAM-HOL-GA76U	inReach Explorer
		RAM-HOL-GA46U	Montana 680t
Handheld Radios		RAM-HOL-UN4	-

ARMS

	PART NUMBER	ARM LENGTH
		RAM-B-103-A-238U
BEST SELLER	RAM-B-103-238U	Medium
	RAM-B-103-C-238U	Long

BASES

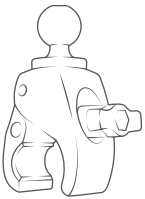
	PART NUMBER	ARM LENGTH
	BEST SELLER	RAP-B-354-TRA1
	RAP-B-400	RAM® Tough-Claw™ Rail Base
	RAM-B-224-1	RAM® Twist-Lock™ Suction Cup
	RAM-B-202	Drill-Down
	RAP-B-378	Flex Adhesive Base

INFLATABLE BOAT & RAFT BASES

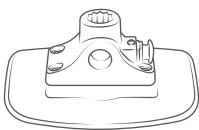
	PART NUMBER	DESCRIPTION
		RAP-398-BLK-TRACK-AU
	RAP-398-BLK-202U	Black RAM® Bond-A-Base™ with C Size 1.5" Ball Base
BEST SELLER	RAP-398-BLK-114BMPU	Black RAM® Bond-A-Base™ with Post/Spline Combo Bulkhead Base
	RAP-B-399U	Strap Adapter with B Size 1" Ball
	RAP-399U	Strap Adapter with C Size 1.5" Ball
	RAP-398-GRY-TRACK-AU	Grey RAM® Bond-A-Base™ with RAM® Tough-Track™
	RAP-398-GRY-202U	Grey RAM® Bond-A-Base™ with C Size 1.5" Ball Base
	RAP-398-GRY-114BMPU	Grey RAM® Bond-A-Base™ with Post/Spline Combo Bulkhead Base

RAM® TOUGH-TRACK™

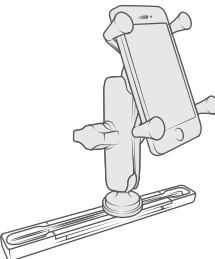
MODULAR ALUMINUM TRACKS					
	PART NUMBER	OVERALL LENGTH	INSIDE TRACK LENGTH	COLOR	DESCRIPTION
		RAM-TRACK-EXA-3BU	6"	3"	Black
	RAM-TRACK-EXA-3	6"	3"	Chrome	-
	RAM-TRACK-EXA-5BU	8"	5"	Black	-
	RAM-TRACK-EXA-5	8"	5"	Chrome	-
BEST SELLER	RAM-TRACK-EXA-9BU	12"	9"	Black	-
	RAM-TRACK-EXA-9	12"	9"	Chrome	-
	RAM-TRACK-EXA-13BU	16"	13"	Black	-
	RAM-TRACK-EXA-13	16"	13"	Chrome	-
	RAM-TRACK-EXA-17BU	20"	17"	Black	-
	RAM-TRACK-EXA-17	20"	17"	Chrome	-
	RAP-TRACK-EXA-CCU	-	-	-	Straight Track Extension Connector
	RAP-TRACK-EXA-CC90U	-	-	-	90-Degree Track Extension Connector

RAM® TOUGH-TRACK™

TOP-LOADING COMPOSITE TRACKS

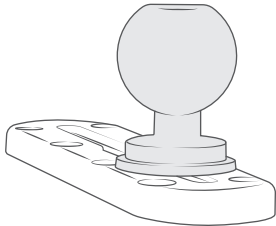

PART NUMBER	MOUNT TYPE	OVERALL LENGTH	CLAMP RANGE
RAP-TRACK-A2	Drill-Down	3.75"	-
RAP-TRACK-A3	Drill-Down	4.75"	-
RAP-TRACK-A5	Drill-Down	7"	-
RAP-TRACK-A9	Drill-Down	10.75"	-
RAP-TRACK-A12	Drill-Down	14.5"	-
RAP-TRACK-A16	Drill-Down	18.5"	-
RAP-400-TRACKU	RAM® Tough-Claw™ Rail System	12"	.625" - 1.5" Diameter
RAP-404-TRACKU	RAM® Tough-Claw™ Rail System	12"	1" - 1.875" Diameter
RAP-401-TRACKU	RAM® Tough-Claw™ Rail System	12"	1" - 2.25" Diameter
RAP-TRACK-B12HU	U-Bolt Rail System	12"	1.75" - 2" Diameter
RAP-TRACK-B12U	U-Bolt Rail System	12"	.625" - 1.25" Diameter
RAP-TRACK-B18HU	U-Bolt Rail System	18"	1.75" - 2" Diameter
RAP-TRACK-B18U	U-Bolt Rail System	18"	.625" - 1.25" Diameter
RAP-TRACK-B7HU	U-Bolt Rail System	7"	1.75" - 2" Diameter
RAP-TRACK-B7U	U-Bolt Rail System	7"	.625" - 1.25" Diameter

RAM® HAND-TRACK™

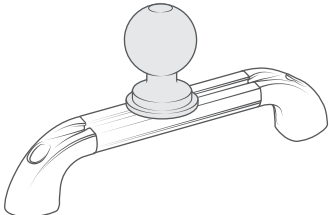

PART NUMBER	TRACK TYPE	OVERALL LENGTH	INSIDE TRACK LENGTH
RAM-TRACK-H12	Complete Track	18"	12"
RAM-TRACK-H4		10"	4"
RAM-TRACK-H6		12"	6"
RAM-TRACK-H8		14"	8"
RAM-TRACK-H10		16"	10"
RAM-TRACK-H15		21"	15"
BEST SELLER RAM-TRACK-H18		24"	18"
RAM-TRACK-H30	Track Extension	36"	30"
RAM-TRACK-HC-4		-	4"
RAM-TRACK-HC-6		-	6"
RAM-TRACK-HC-8		-	8"
RAM-TRACK-HC-10		-	10"
RAM-TRACK-HC-12		-	12"
RAM-TRACK-HC-15		-	15"
RAM-TRACK-HC-18		-	18"
RAM-TRACK-HC-30U	-	-	30"

RAM® CUP HOLDER MOUNTS

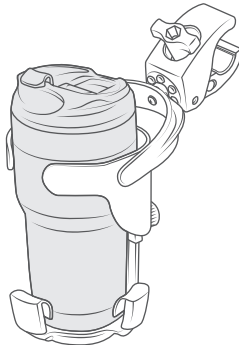

PART NUMBER	DRINK SIZE	MOUNT TYPE	DESCRIPTION
RAM-B-132BU	16 oz	-	Holder Only - B Size 1" Ball
RAP-B-417BU	16-32 oz	-	Holder Only - B Size 1" Ball
RAM-B-132U	16 oz	Drill-Down	Double Ball Mount
RAM-B-132-400U	16 oz	RAM® Tough-Claw™ Rail Base	
BEST SELLER RAP-B-417-400U	16-32 oz	RAM® Tough-Claw™ Rail Base	Low-Profile Mount
RAP-429TU	16-32 oz	Track	Low-Profile Mount
RAM-B-417B-C-TRA1U	16-32 oz	Track	Long Double Ball Mount



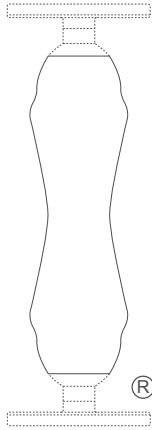

THE SHAPE THAT STARTED IT ALL

RAM® double socket arms with their distinctive Hourglass Shape are recognized globally as a symbol of the reliability, quality and durability of this line of products. The Hourglass Shape is a registered trademark of National Products Inc.

The unique RAM® Mounts system offers a full line of interchangeable mounting bases, extensions, device adapters, and accessories to secure your devices where you want it. See all of the innovative products and solutions RAM® manufactures at rammount.com.



THE DISTINCTIVE “D” PRODUCT SHAPE

of the GDS® connector is a trademark of National Products Inc.



THE DISTINCTIVE RAM® “X-GRIP®”

product shape is a trademark of National Products Inc.



LOOK FOR THE HIGHLY RECOGNIZABLE “DOUBLE DELTA” TRADEMARK,
the symbol of quality and reliability

RAM® MOUNTS IS A DIVISION OF NATIONAL PRODUCTS INC.

8410 Dallas Avenue South
Seattle, WA 98108
Phone: 800.497.7479
sales@rammount.com
rammount.com

Lifetime Warranty
Patents and Trademarks
rammount.com/ip

National Products Inc.
Would like to thank the following:
Master Marine Boat Center Inc.
Nixon's Marine Inc.
Waypoint Marine Group
Wooldridge Boats Inc.



CONTACT US

sales@rammount.com
1-800-497-7479

JOIN OUR COMMUNITY



NPI-CAT-ONWATER20

July 2020

